

OCTH-LK30-BB - October 17, 2022

Item # OCTH-LK30-BB was discontinued on October 17, 2022. For informational purposes, this is a copy of the website content at that time and is valid only for the stated product.

GANYMEDE™ SERIES SD-OCT SYSTEMS

**Ganymede™ Series
Spectral Domain OCT
Imaging System**

*High-Resolution
Imaging*

**LASER RADIATION
DO NOT VIEW DIRECTLY WITH
OPTICAL INSTRUMENTS
CLASS 1M LASER PRODUCT**

Features

- Configurable High-Resolution OCT Systems
- SD-OCT Systems with 880 nm, 900 nm, or 930 nm Center Wavelength (See Tables Below for Specifications)
 - A-Scan Rates up to 248 kHz

OCT Family Updates

We recently improved the OCT Base Units, and the new additions include:

- Fully Configurable Trigger for Integration into Larger Experiments
- Analog Input for Combining Other Data Sources with the OCT Signal
- Internal Hardware Diagnostics for Improved Troubleshooting

The SD-OCT standard scanners have also been redesigned with a new micrometer screw for more precise reference arm positioning.

New features added to ThorImage®OCT include a despeckle filter, 3D speckle variance mode, and automatic peak detection.

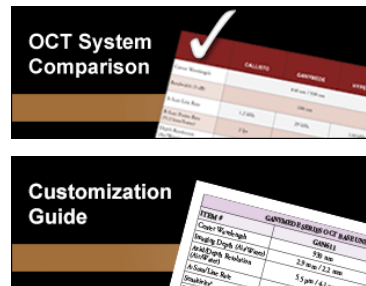

- Imaging Depths in Air up to 3.4 mm
- Axial Resolutions in Air from 3.0 to 6.0 μm
- Sensitivities up to 106 dB
- Includes Computer and ThorImage®OCT Software Package (See the *Software* Tab)
- Build-Your-Own and Preconfigured Systems Available

Choose Components to Build or Customize Your OCT System

- Choose from Base Units Optimized for a Range of Applications
- Standard, User-Customizable, and Handheld Scanners Available
- Data Acquisition via USB 3.0 or CameraLink Connection
- Scan Lens Kits to Optimize Lateral Resolution and Focal Length for Your Application

Exploring the Options?



We can provide tailored recommendations and partner with you to obtain images of your samples, demonstrating the impact of the OCT base unit and probe optics on image quality. Demos of our OCT systems can be arranged at our Sterling, VA (USA); Shanghai, China; Tokyo, Japan; and Lübeck, Germany facilities. See the *OCT Demo Rooms* tab.

In the Budgetary Phase?

System prices vary based on the exact components. Through our conversations, we can ensure your system quote is tailored to your requirements.

OEM or Custom Projects?

Click here to learn about our OEM capabilities.



OCT Applications Team Based in Lübeck, Germany

We're Happy to Assist!

[Contact Us](#)

[Application Articles](#)

- Ring- and Immersion-Style Sample Z-Spacers for Air or Liquid Imaging Applications
- Scanner Stand and Translation Stage Accessories
- Contact Our OCT Team to Request a Quote and Discuss Building a System

Optical Coherence Tomography (OCT) is a noninvasive optical imaging technique that produces real-time, 2D cross-sectional and 3D volumetric images of a sample. This technique provides structural information about the sample based on light backscattered from different layers of material within that sample, producing images with micron-level resolution and millimeters of imaging depth. OCT imaging can be considered as an optical analog to ultrasound imaging that achieves higher resolution at the cost of decreased penetration depth. In addition to high resolution, the non-contact, noninvasive nature of OCT makes it well suited for imaging samples such as biological tissue, small animals, and industrial materials.

Thorlabs' Ganymede™ Series of OCT Imaging Systems provide the flexibility required for high-resolution imaging applications with A-scan line rates up to 248 kHz. The 64-bit software pre-installed on the included computer displays and processes 2D and 3D OCT data in real time. Choose from a number of scanner options including a robust standard scanner, user-customizable scanner, and the portable handheld scanner. Optional accessories are available below to customize your OCT system to meet the requirements of your application. Additionally, Thorlabs offers five complete, preconfigured OCT systems operating with 880 nm, 930 nm, or 900 nm center wavelengths based on the components sold on this page.

The components below can also be used to upgrade your existing Thorlabs OCT system with additional features and are fully compatible out of the box with Thorlabs' OCT systems and accessories. While most systems are upgradable, we recommend contacting the OCT Team to determine the optimal solution for your system and intended application.

Click on the Image Below or in the Table to the Right for Details on Customization Options



Ganymede Customization Options
OCT Base Unit (Computer Included)
Scanning System
Scan Lens Kit



Ganymede Customization Options
Reference Length Adapter (For Standard Scanners Only)
Adjustable Scanner Stand
Translation Stage
Preconfigured Systems

ThorImage® OCT Software Index

- Introduction
 - Scan Control
 - Processing Options for Improving the Image Quality of OCT Images
 - Data Analysis for Measuring the Thickness of Layers
 - Third-Party Applications to Export/Reimport OCT Data
- Imaging Modes
 - 1D Mode for Single Point Measurements
 - 2D Mode for Cross-Sectional Imaging
 - 3D Mode for Volume Imaging
 - Doppler Mode for Doppler Flow Imaging
 - Speckle Variance Mode for Angiographic Imaging
- Externally-Triggered Acquisition for Synchronized Measurements
- Analog Input for Synchronization with other Modalities
- Software Development Kits for Writing Custom Programs
- Probe Calibration for Different Configurations
- Video Showing Screenshot of Rendering Capabilities

ThorImageOCT Software



- Interactive Scan Position Control through Video Display for Common Line Scans or Freeform Pattern Scans
- Advanced Dataset Management
- Access to Raw Spectra, Processed Data, and All Calibration Files Necessary for User-Designed Processing Routines
- High-Speed Volume Rendering of 3D Data
- Doppler and Speckle Variance Imaging
- Versatile Scan and Acquisition Control, such as Averaging or Adjustable Scan Speeds

ThorImageOCT is a high-performance data acquisition software that is included with all Thorlabs OCT systems. This 64-bit Windows-based software acquires and displays OCT data, as well as includes scan control and processing options. Additionally, NI LabVIEW and C-based Software Development Kits (SDKs) are available, which contain a complete set of libraries for measurement control, data acquisition, and processing, as well as for storage and display of OCT images. The SDKs provide the means for developing highly specialized OCT imaging software for every individual application.

Scan Control

ThorImageOCT provides numerous scan and acquisition controls. The camera integrated in the scanner of our OCT systems provides live video images in the application software. Defining the scan line for 2D imaging or the scan area for 3D imaging is accomplished through the easy-to-use "Draw and Scan" feature by clicking on the video image.

ThorImageOCT Documentation

ThorImageOCT Software Manual	
Third-Party Software License Agreements	

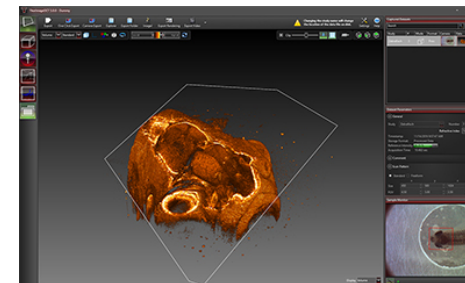

Click to Enlarge

Rendered Volume of a Zebrafish with Modifiable Clipping Plane

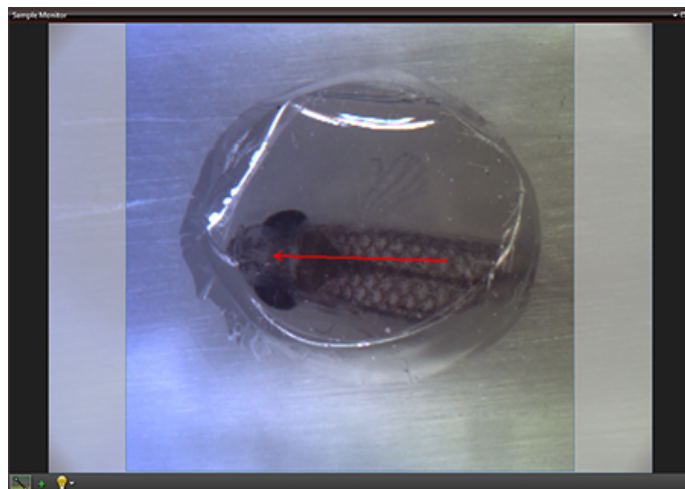

Click to Enlarge

The Sample Monitor can be used to define the scan pattern using the "Draw and Scan" feature.

Arbitrary forms defined by the Draw & Scan feature or loaded .txt files can be scanned. The scan pattern can also be adjusted by specifying suitable parameters in the controls of the software, as shown to the right.



Click to Enlarge

Various acquisition parameters can be adjusted in ThorImageOCT.



Click to Enlarge

A predefined circle scan pattern can be loaded and scanned in the software. The size can be changed with the Zoom feature.

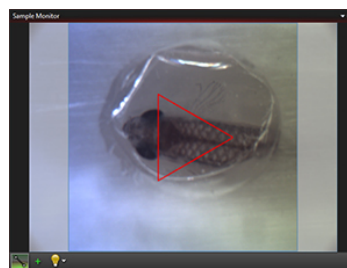

Click to Enlarge

A predefined triangle scan pattern can be loaded and scanned in the software. The size can be changed with the Zoom feature.

Additionally, one can further set processing parameters, averaging parameters, and the speed and sensitivity of the device using device presets. By using a high-speed preset, video-like frame rates in 2D and fast volume rendering in 3D are possible, whereas high-sensitivity acquisition is enabled by choosing a preset with a lower acquisition speed.

Processing Options

ThorImageOCT provides features specifically designed to improve the quality of OCT images. The data can be modified during acquisition using processing parameters, such as image field correction and undersampling filters, or afterwards with filters. As shown to the right, the despeckle filter can be applied to an image to reduce speckle noise without blurring details of the imaged structure.

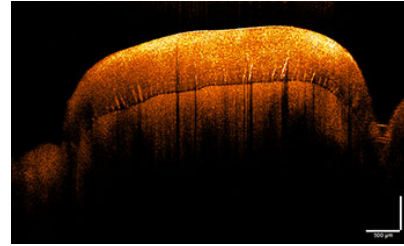

Click to Enlarge
OCT Image of a Human Tooth

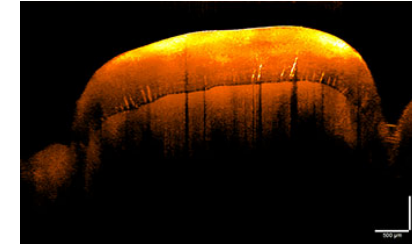

Click to Enlarge
Despeckle Filter Applied to an OCT Image of a Human Tooth

If additional processing functions are desired, ThorImageOCT can also integrate user-defined post-processing algorithms; see the Third Party Applications section for more details.

Data Analysis

ThorImageOCT includes several tools for convenient data analysis. The integrated marker tool serves to measure distances, as well as the structure size. Additionally, this tool can be used to display intensity profile of the OCT data across a line. For precise distance and thickness measurements, the refractive index of the material under investigation can be set.

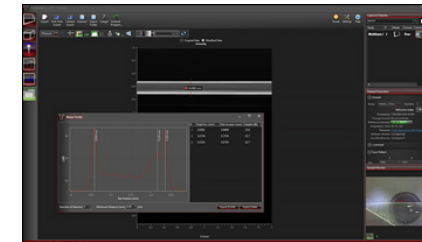

Click to Enlarge
The marker tool can be used to measure layer thickness.

Dataset Management

ThorImageOCT provides advanced dataset management capabilities, which allow several datasets to be opened simultaneously. Datasets are uniquely defined using an identifier consisting of a study (or test series) name and an experiment number. Grouping of datasets can be achieved by using the same study name. The "Captured Datasets" list shows an overview of all open datasets, including the dataset identifier, the acquisition mode, and preview pictures of the still video image and the OCT data.

Datasets can be exported in various image formats, such as PNG, BMP, JPEG, PDF, or TIFF. The set can also be exported in complete data formats suited for post-processing purposes, such as RAW/SRM, FITS, VTK, VFF, and 32-bit floating-point TIFF.

The OCT file format native to ThorImageOCT allows OCT data, sample monitor data, and all relevant metadata to be stored in a single file. ThorImageOCT can also be installed and run on computers without OCT devices in order to view and export OCT data. The user has full access to the raw and processed data from the device, including additional data used for processing,

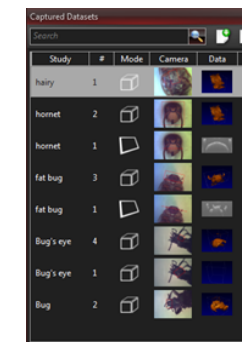

Click to Enlarge
The Dataset Management Window of ThorImageOCT

e.g. offset errors.

Third-Party Applications

If both ImageJ and ThorImageOCT are installed on the computer, opening acquired OCT data in ImageJ is one mouse click away. This enables a smooth workflow when requiring the advanced image processing functionality provided by ImageJ. Clicking the Explorer button will open the folder and select the file in Windows Explorer where the currently active dataset is stored.

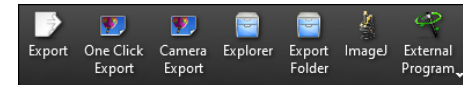

Export buttons are accessible in the Action Toolbar of ThorImageOCT.

Acquired OCT datasets can also be exported and modified in a third-party program, and then reimported back into the ThorImageOCT software. This functionality allows for fast and customized modifications of OCT images, while still using the dataset management of the ThorImageOCT software. As shown in the example to the right, OCT data (left) can be exported to ImageJ and a smoothing filter applied in the lateral direction (center). Using the "External Program" button allows the modified data to be reimported into ThorImageOCT for further analysis. For example, the peak detection tool can be used to measure the layer thicknesses (right).

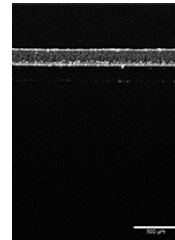

Click to Enlarge
OCT data of a plastic multilayered film with speckle.

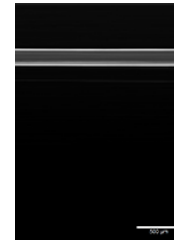

Click to Enlarge
A filter for smoothing lateral directions is applied to the image in ImageJ.

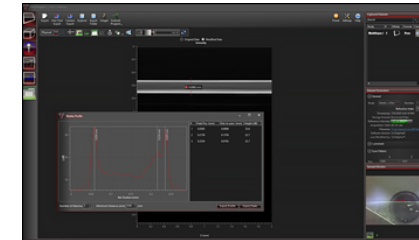

Click to Enlarge
After smoothing the data in ImageJ, the marker tool in ThorImageOCT can be used to measure layer thickness.

Imaging Modes

Different OCT imaging modes can be selected using the mode selector. If the ThorImageOCT software finds a compatible system connected and switched on, all operational modes will be selectable. If no OCT device is present, only the data viewing mode for viewing and OCT data export will be available.

1D Mode

In this mode, single-point measurements can be made that provide spectral and depth information, as well as the ability to observe time-related sample behavior with an M-scan.

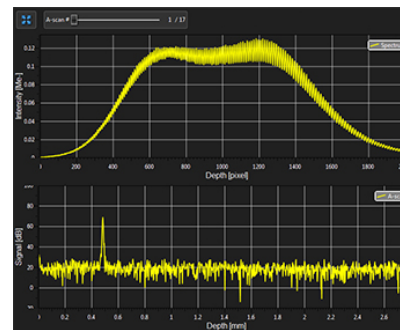

Click to Enlarge

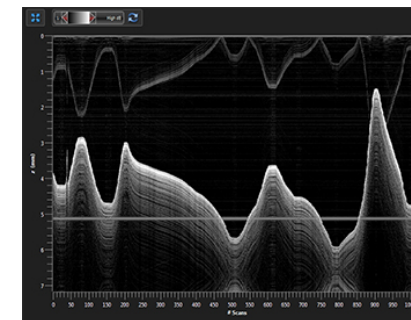

Click to Enlarge
Several A-Scans at a Single Point Over Time (M-Scan)

Spectral and Depth Information for a Single Point (A-Scan)

2D Mode

In the 2D imaging mode, the probe beam scans in one direction, acquiring cross-sectional OCT images which are then displayed in real time. Line averaging before or after the Fast Fourier Transform (FFT) is available, as well as B-Scan averaging. For long term measurements, a time series function, which has an adjustable time interval between two acquisitions, is included. Image display parameters, such as color mapping, can be controlled in this mode. We have also implemented an option for automatic calculation of the optimum contrast and brightness of the displayed OCT images.

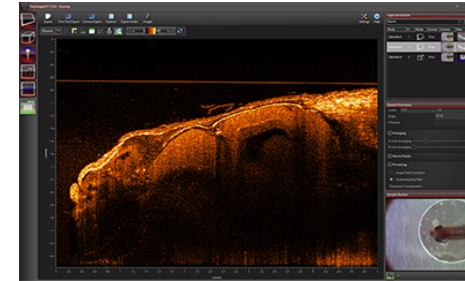

Click to Enlarge
ThorImageOCT Window in the 2D Mode

3D Mode

In the 3D imaging mode, the OCT probe beam scans sequentially across the sample to collect a series of 2D cross-sectional images which are then processed to build a 3D image.

To accommodate long term measurements, a time series function that takes a series of 3D measurements is available. The number of volumes to be acquired and the time interval between scans are adjustable.

In the ThorImageOCT software, 3D volume datasets can be viewed as orthogonal cross-sectional planes (see below) and volume renderings.

The Sectional View features cross-sectional images in all three orthogonal planes, independent of the orientation in which the data was acquired. The view can be rotated as well as zoomed in and out.

The Rendering View provides a volumetric rendering of the acquired volume dataset. This view enables quick 3D visualization of the sample being imaged. Planes of any orientation can be clipped to expose structures within the volume. The 3D image can be zoomed in and out as well as rotated. Furthermore, the coloring and dynamic range settings can be adjusted.

Utilizing the full potential of our high-performance software in combination with our high-speed OCT systems, we have included a Fast Volume Rendering Mode in the ThorImageOCT software, which serves as a preview for high-resolution 3D acquisitions. In this mode, high-speed volume renderings can be displayed in real-time, providing rapid visualization of samples in three dimensions.

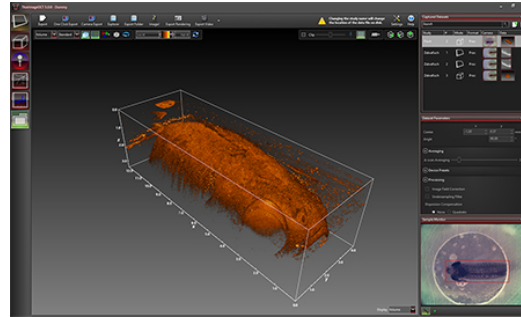

Click to Enlarge
Rendering View in ThorImageOCT

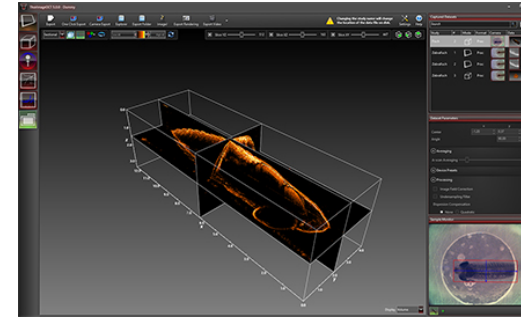

Click to Enlarge
Sectional View in ThorImageOCT

Doppler Mode

Doppler OCT imaging comes standard with all OCT systems. In the Doppler mode, phase shifts between adjacent A-scans are averaged to calculate the Doppler frequency shift induced by particle motion or flow. The number of lateral and axial pixels can be modified to change velocity sensitivity and resolution during phase shift calculation. The Doppler images are displayed in the main window with a color map indicating forward- or backward-directed flow, relative to the OCT beam.

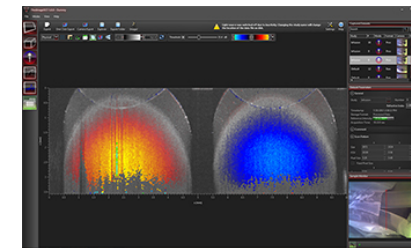

Click to Enlarge
Doppler dataset showing the velocity of a rotated plastic stick with opposite flow directions.

Speckle Variance Mode

The speckle variance imaging mode is an acquisition mode which uses the variance of speckle noise to calculate angiographic images. It can be used to visualize three dimensional vessel trees without requiring significant blood flow and without requiring a specific acquisition speed window. The speckle variance data can be overlaid on top of intensity pictures providing morphological information. Different color maps can be used to display the multimodal pictures.

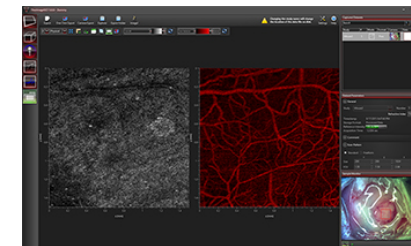

Click to Enlarge
Speckle variance measurement showing blood vessels of a mouse brain.

Externally-Triggered Acquisition

ThorImageOCT and the SDK APIs provide the ability to externally trigger the acquisition of A-Scans. This enables the user to synchronize measurements from different modalities (e.g. vibrometry and synchronized positioning) with an OCT measurement. Synchronization is greatly simplified with all current CameraLink-based Thorlabs OCT systems (a TTL level trigger signal source required). External triggering is available for all imaging modes and can be toggled in the settings dialog in ThorImageOCT.

Thorlabs' current generation of Ganymede (Item # GAN6x1) and Telesto (Item #s TELxx1 & TELxx1PS) SD-OCT Systems include an external B-Scan trigger for synchronization with other experiments.

Analog Input for Synchronization with Other Modalities

Thorlabs' current generation of Ganymede (Item # GAN6x1) and Telesto (Item #s TELxx1 & TELxx1PS) SD-OCT Systems include two analog input channels, which can be used to combine imaging modalities. The analog signal from another data source (i.e., fluorescence signal) is sampled and displayed simultaneously with the OCT signal.

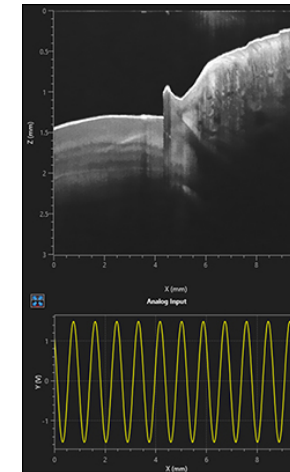

Click to Enlarge
Analog Data Visualization in the 2D
Display

Software Development Kits

For maximum flexibility, customized solutions can be implemented in ThorImageOCT using software development kits (SDKs). Experienced software developers can use these in a multitude of programming environments to tailor the use of Thorlabs OCT systems to their specific application. SDKs are available in:

- ANSI C with C++ Demo Programs
- LabVIEW® Including Demo Programs and Advanced Sample Code

Probe Calibration

Changing to a different scan lens kit will generally require a different probe configuration in order to adapt to changes in the optical parameters of the system. When an additional scan lens is purchased for your Thorlabs OCT scanner system, ThorImageOCT enables you to easily create a fitting configuration for your new scan lens by using the calibration sample shipped with the lens and an intuitive step-by-step calibration process (shown to the right).

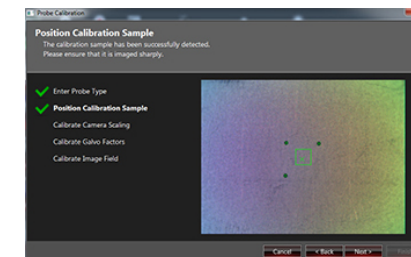

Click to Enlarge
Probe Calibration Window in ThorImageOCT



Video Showing Screencast of ThorImageOCT Rendering Capabilities

In this video, OCT images of a finger are acquired and manipulated in the 3D volume and cross section modes.

For information on the availability of ThorImageOCT version 5.4, please contact our OCT Support Team.

Optical Coherence Tomography Tutorial

Optical Coherence Tomography (OCT) is a noninvasive optical imaging modality that provides real-time, 1D depth, 2D cross-sectional, and 3D volumetric images with micron-level resolution and millimeters of imaging depth. OCT images consist of structural information from a sample based on light backscattered from different layers of material within the sample. It can provide real-time imaging and is capable of being enhanced using birefringence contrast or functional blood flow imaging with optional extensions to the technology.

Thorlabs has designed a broad range of OCT imaging systems that cover several wavelengths, imaging resolutions, and speeds, while having a compact footprint for easy portability. Also, to increase our ability to provide OCT imaging systems that meet each customer's unique requirements, we have designed a highly modular technology that can be optimized for varying applications.

Application Examples

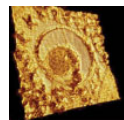

Art
Conservation

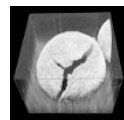

Drug Coatings

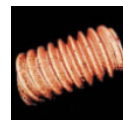

3D Profiling

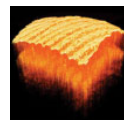

In Vivo

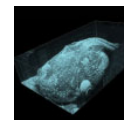

Small Animal

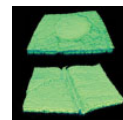

Biology

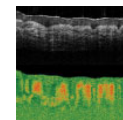

Tissue
Birefringence



Mouse Lung



Retina Cone
Cells

OCT is the optical analog of ultrasound, with the tradeoff being lower imaging depth for significantly higher resolution (see Figure

1). With up to 15 mm imaging range and better than 5 micrometers in axial resolution, OCT fills a niche between ultrasound and confocal microscopy.

In addition to high resolution and greater imaging depth, the non-contact, noninvasive advantage of OCT makes it well suited for imaging samples such as biological tissue, small animals, and materials. Recent advances in OCT have led to a new class of technologies called Fourier Domain OCT, which has enabled high-speed imaging at rates greater than 700,000 lines per second.¹

Fourier Domain Optical Coherence Tomography (FD-OCT; Figure 2) is based on low-coherence interferometry, which utilizes the coherent properties of a light source to measure optical path length delays in a sample. In OCT, to obtain cross-sectional images with micron-level resolution, and interferometer is set up to measure optical path length differences between light reflected from the sample and reference arms.

There are two types of FD-OCT systems, each characterized by its light source and detection schemes: Spectral Domain OCT (SD-OCT) and Swept Source OCT (SS-OCT). In both types of systems, light is divided into sample and reference arms of an interferometer setup, as illustrated in Figure 3. SS-OCT uses coherent and narrowband light, whereas SD-OCT systems utilize broadband, low-coherence light sources. Back scattered light, attributed to variations in the index of refraction within a sample, is recoupled into the sample arm fiber and then combined with the light that has traveled a fixed optical path length along the reference arm. A resulting interferogram is measured through the detection arm of the interferometer.

The frequency of the interferogram measured by the sensor is related to depth locations of the reflectors in the sample. As a result, a depth reflectivity profile (A-scan) is produced by taking a Fourier transform of the detected interferogram. 2D cross-sectional images (B-scans) are produced by scanning the OCT sample beam across the sample. As the sample arm beam is scanned across the sample, a series of A-scans are collected to create the 2D image.

Similarly, when the OCT beam is scanned in a second direction, a series of 2D images are collected to produce a 3D volume data set. With FD-OCT, 2D images are collected on a time scale of milliseconds, and 3D images can be collected at rates now below 1 second.

Spectral Domain OCT vs. Swept Source OCT

Spectral Domain and Swept Source OCT systems are based on the same fundamental principle but incorporate different technical approaches for producing the OCT interferogram. SD-OCT systems have no moving parts and therefore have high mechanical stability and low phase noise. Availability of a broad range of line cameras has also enabled development of SD-OCT systems with varying imaging speeds and sensitivities.

SS-OCT systems utilize a frequency swept light source and photodetector to rapidly generate the same type of interferogram. Due to the rapid sweeping of the swept laser source, high peak powers at each discrete wavelength can be used to illuminate the sample to provide greater sensitivity with little risk of optical damage.

FD-OCT Signal Processing

In Fourier Domain OCT, the interferogram is detected as a function of optical frequency. With a fixed optical delay in the reference arm, light reflected from different sample depths produces interference patterns with the different frequency components. A Fourier transform is used to resolve different depth reflections, thereby generating a depth profile of the sample (A-scan).

¹V. Jayaraman, J. Jiang, H. Li, P. Heim, G. Cole, B. Potsaid, J. Fujimoto, and A. Cable, "OCT Imaging up to 760 kHz Axial Scan Rate Using Single-Mode 1310 nm MEMs-Tunable VCSELs with 100 nm Tuning Range," CLEO 2011 - Laser Applications to Photonic Applications, paper PDPB2 (2011).

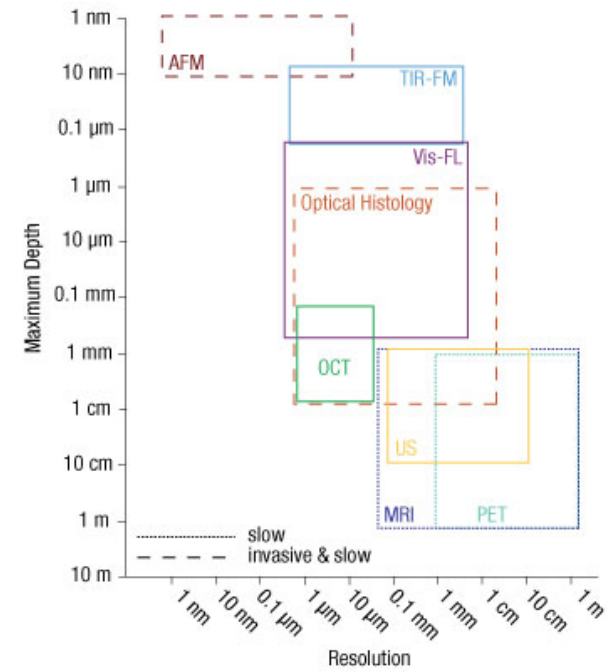

Click to Enlarge

Figure 1

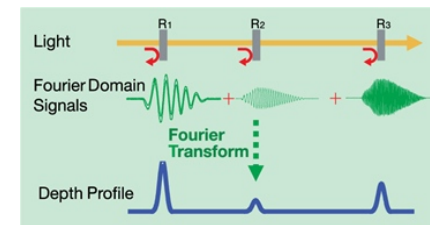

Click to Enlarge

Figure 2

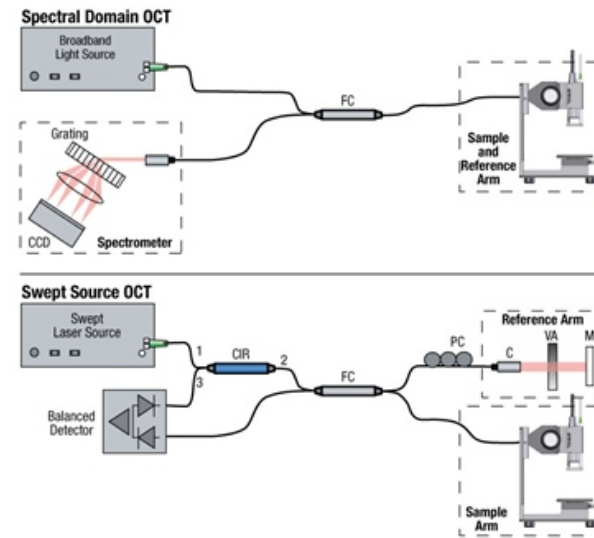

Click to Enlarge
Figure 3

Brochure and Configuration Chart

The buttons below link to PDFs of printable materials and a graphical customization guide for our Ganymede™ Series OCT Systems.



Ganymede™ Series OCT Systems

GANYMEDI SERIES PRECONFIGURED SYSTEMS					
ITEM #	GAN11C1	GAN31C1	GAN61C1	GAN21C1	GAN621C1
Base Unit	GAN11	GAN31	GAN61	GAN21	GAN621
Center Wavelength	880 nm	930 nm	930 nm	930 nm	930 nm
Scanning System	OCTG (Standard Scanner)				
Scan Lens Kit	OCT-LK3-BB	OCT-LK4-BB	OCT-LK3-BB	OCT-LK3-BB	OCT-LK3-BB
Reference Length Adapter	OCT-RA3	OCT-RA3	OCT-RA3	OCT-RA2	OCT-RA2
Accessories	OCT-STAND0(M) and OCT-XYR10(M)				

GAN611C1
The GAN611C1 configuration consists of a GAN611 high-resolution and high-sensitivity 930 nm base unit, standard scanner, general-purpose scan lens kit, reference length adapter, stand, and stage.

Step 1: Choose a Base Unit

Step 2: Choose a Scanning System

Step 3: Choose a Scan Lens Kit

Step 4: Choose a Z-Spacer (Optional)

Step 5: Choose Accessories (Optional)

Available Base Units:

- GAN11 High-Resolution Imaging
- GAN31 High-Resolution and High-Speed Imaging
- GAN21 Very High-Resolution and High-Speed Imaging
- GAN61 High-Resolution and Very High-Speed Imaging
- GAN621 Very High-Resolution and Very High-Speed Imaging

GANYMEDI SERIES BASE UNIT SPECIFICATIONS					
ITEM #	GAN11	GAN31	GAN61	GAN21	GAN621
Center Wavelength	880 nm	930 nm	930 nm	930 nm	930 nm
Imaging Depth (Air/Water)	3.4 mm / 2.5 mm	2.9 mm / 2.2 mm	1.9 mm / 1.4 mm		
Axial/Depth Resolution (Air/Water)	6.0 µm / 4.5 µm	5.5 µm / 4.1 µm	3.0 µm / 2.2 µm		
A-Scan/Lin Rate	1.5 MHz to 30 MHz	1.5 MHz to 80 MHz	3 MHz to 240 MHz	1.5 MHz to 80 MHz	3 MHz to 240 MHz
Sensitivity	106 dB (at 1.5 kHz)	96 dB (at 1.5 kHz)	102 dB (at 5 MHz)	106 dB (at 1.5 kHz)	102 dB (at 5 MHz)
Base Unit Dimensions	411.8 mm x 525.0 mm x 143.0 mm				

*Typical Values Measured Using a Common Path Probe with 10% Beam splitter

OCT DEMO ROOMS

Try Our OCT Imaging Systems In Person or Virtually

From our OCT facility in Lübeck, Germany and offices in Virginia, USA; Tokyo, Japan; and Shanghai, China; Thorlabs' application specialists and sales engineers look forward to helping you determine the best OCT system to meet your specific experimental needs. We can provide tailored recommendations and partner with you to obtain images of your samples, demonstrating the impact of the OCT base unit and probe optics on image quality.

Thorlabs' worldwide network allows us to operate demo rooms in a number of locations where you can see our OCT systems in action. We welcome the opportunity to work with you in person or virtually. A demo can be scheduled at any of our showrooms or virtually by contacting OCT@thorlabs.com.

Last Edited by: Zoe Hughes on 03/18/2021

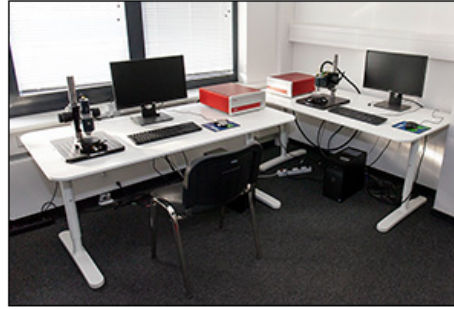

[Click to Enlarge](#)
Lübeck Demo Room

To schedule an in-person or virtual demo appointment, please email OCT@thorlabs.com.



[Contact Us](#)

Demo Rooms and Customer Support Sites (Click Each Location for More Details)

Lübeck, Germany



[Click to Enlarge](#)

Thorlabs GmbH

Maria-Goeppert-Straße 9
23562 Lübeck

Customer Support

- Phone: +49 (0) 8131-5956-40840
- Email: oct@thorlabs.com

Demo Rooms

Customer Support Sites (Click Each Location for More Details)

Newton, New Jersey, USA



[Click to Enlarge](#)

Thorlabs HQ

56 Sparta Avenue
Newton, NJ 07860

Customer Support

- Phone: (973) 300-3000
- E-mail: techsupport@thorlabs.com

Demo Rooms

- [Ganymede™ Series SD-OCT Systems](#)
- [Telesto® Series SD-OCT Systems](#)
- [Telesto® Series PS-OCT Systems](#)
- [Atria® Series SS-OCT Systems](#)
- [Vega™ Series SS-OCT Systems](#)

Sterling, Virginia, USA



[Click to Enlarge](#)

Thorlabs Imaging Systems HQ

Ely, United Kingdom



[Click to Enlarge](#)

Thorlabs Ltd.

1 Saint Thomas Place, Ely
Ely CB7 4EX

Customer Support

- Phone: +44 (0)1353-654440
- E-mail: techsupport.uk@thorlabs.com

Bergkirchen, Germany

108 Powers Court
Sterling, VA 20166

Customer Support

- Phone: (703) 651-1700
- E-mail: ImagingTechSupport@thorlabs.com

Demo Rooms

- [Ganymede™ Series SD-OCT Systems](#)
- [Telesto® Series SD-OCT Systems](#)

Nerima-ku, Tokyo, Japan



[Click to Enlarge](#)

Thorlabs Japan, Inc.

3-6-3 Kitamachi
Nerima-ku, Tokyo 179-0081

Customer Support

- Phone: +81-3-6915-7701
- Email: sales@thorlabs.jp

Demo Rooms

- [Ganymede™ Series SD-OCT Systems](#)

Shanghai, China



[Click to Enlarge](#)

Thorlabs GmbH

Münchner Weg 1
85232 Bergkirchen

Customer Support

- Phone: +49 (0) 8131-5956-0
- E-mail: europa@thorlabs.com

Maisons-Laffitte, France



[Click to Enlarge](#)

Thorlabs SAS



[Click to Enlarge](#)

Thorlabs China

Room A101, No. 100, Lane 2891, South Qilianshan Road
Shanghai 200331

Customer Support

- Phone: +86 (0)21-60561122
- Email: techsupport-cn@thorlabs.com

Demo Rooms

- [Ganymede™ Series SD-OCT Systems](#)
- [Telesto® Series SD-OCT Systems](#)

109, rue des Cotes
Maisons-Laffitte 78600

Customer Support

- Phone: +33 (0)970 440 844
- E-mail: techsupport.fr@thorlabs.com

São Carlos, SP, Brazil



[Click to Enlarge](#)

Thorlabs Vendas de Fotônicos Ltda.

Rua Rosalino Bellini, 175
Jardim Santa Paula
São Carlos, SP, 13564-050

Customer Support

- Phone: +55-16-3413 7062
- E-mail: brasil@thorlabs.com

SELECTION GUIDE

Thorlabs offers a variety of OCT Imaging Systems to meet a range of application requirements. The OCT base unit and scan lens kit are key to OCT system performance. Significant performance characteristics, including axial resolution, A-Scan rate, and imaging depth, are entirely or strongly dependent on the design of the OCT base unit. The choice of scan lens kit determines other parameters, such as lateral resolution and field of view. Thorlabs offers a variety of OCT base units and scan lens kits that provide foundations for systems with a wide range of capabilities. The tables below present key performance parameters of our base units and include links to our other OCT imaging system pages. We encourage you to contact us directly at oct@thorlabs.com or via our online request form to discuss specific imaging requirements.

Swept Source OCT Base Units

Base Unit Item # ^a	ATR206	ATR220	VEG210	VEG220
Series Name (Click for Link)	Atria [®]		Vega [™]	
Key Performance Feature(s)	Long Imaging Range	High Speed	Long Imaging Range	
	High Resolution		General Purpose	High Speed
Center Wavelength	1060 nm		1300 nm	
Imaging Depth ^b (Air/Water)	20 mm / 15 mm	6.0 mm / 4.5 mm	11 mm / 8.3 mm	8.0 mm / 6.0 mm
Axial Resolution ^b (Air/Water)	11 μ m / 8.3 μ m		14 μ m / 10.6 μ m	
A-Scan Line Rate	60 kHz	200 kHz	100 kHz	200 kHz
Sensitivity (Max) ^c	102 dB	97 dB	102 dB	98 dB

- These Item #s are OCT base units that can be customized using a wide selection of OCT scanners, lens kits, and optional accessories.
- Axial resolution and actual imaging depth are dependent on the optical properties of the sample being imaged.
- Values measured for the Atria and Vega systems are typical and were measured using a scanner with a dual path setup.

Spectral Domain OCT Base Units

Base Unit Item # ^a	GAN111	GAN311	GAN611	GAN321	GAN621
Series Name	Ganymede [™]				
Key Performance Feature(s)	High Resolution	High Resolution		Very High Resolution	
		High Speed	Very High Speed	High Speed	Very High Speed
Center Wavelength	880 nm	930 nm		900 nm	

Base Unit Item # ^a	GAN111	GAN311	GAN611	GAN321	GAN621
Imaging Depth ^b (Air/Water)	3.4 mm / 2.5 mm	2.9 mm / 2.2 mm		1.9 mm / 1.4 mm	
Axial Resolution ^b (Air/Water)	6.0 μm / 4.5 μm	5.5 μm / 4.1 μm		3.0 μm / 2.2 μm	
A-Scan Line Rate	1.5 kHz to 20 kHz	1.5 kHz to 80 kHz	5 kHz to 248 kHz	1.5 kHz to 80 kHz	5 kHz to 248 kHz
Sensitivity (Max) ^c	106 dB	106 dB	102 dB	106 dB	102 dB

- a. These Item #s are OCT base units that can be customized using a wide selection of OCT scanners, lens kits, and optional accessories.
- b. Axial resolution and actual imaging depth are dependent on the optical properties of the sample being imaged.
- c. Values for the Ganymede systems are typical and were measured using a scanner with a common reference/sample path and 50% path split.

Base Unit Item # ^a	TEL221	TEL311	TEL221	TEL321	TEL211PS	TEL221PS
Series Name (Click for Link)	Telesto [®]				Telesto [®] PS-OCT	
Key Performance Feature(s)	High Imaging Depth		High Resolution		High Imaging Depth	High Resolution
	General Purpose	High Speed	General Purpose	High Speed	Polarization Sensitive-Imaging	
Center Wavelength	1325 nm		1300 nm		1325 nm	1300 nm
Imaging Depth ^b (Air/Water)	7.0 mm / 5.3 mm		3.5 mm / 2.6 mm		7.0 mm / 5.3 mm	3.5 mm / 2.6 mm
Axial Resolution ^b (Air/Water)	11 μm / 8.3 μm		5.5 μm / 4.2 μm		11 μm / 8.3 μm	5.5 μm / 4.2 μm
A-Scan Line Rate	5.5 kHz to 76 kHz	10 kHz to 146 kHz	5.5 kHz to 76 kHz	10 kHz to 146 kHz	5.5 kHz to 76 kHz	5.5 kHz to 76 kHz
Sensitivity (Max) ^c	111 dB	109 dB	111 dB	109 dB	109 dB	109 dB

- a. These Item #s are OCT base units that can be customized using a wide selection of OCT scanners, lens kits, and optional accessories.
- b. Axial resolution and actual imaging depth are dependent on the optical properties of the sample being imaged.
- c. Values for the Telesto systems are typical and were measured using a scanner with a common reference/sample path and 50% path split.

Ganymede™ Series Complete Preconfigured Systems

- ▶ Complete Preconfigured 880 nm, 900 nm, or 930 nm OCT Systems (See Tables Below)
- ▶ Fully Customizable Using Other Ganymede™ Series Components
- ▶ Configurable Trigger for Integration into Larger Experiments
- ▶ Analog Input for Combining Other Data Sources with the OCT Signal
- ▶ Internal Hardware Diagnostics for Improved Troubleshooting
- ▶ Metric Preconfigured OCT Systems Available; Contact Our OCT Team for More Information

Thorlabs offers five complete, preconfigured Ganymede OCT systems, each of which is fully compatible with all Ganymede Series OCT components. The GAN111C1 system operates at 880 nm center wavelength and offers high-resolution imaging capability. The GAN311C1 and GAN611C1 configurations feature a center wavelength of 930 nm and are ideal for high-speed, high-resolution imaging applications. Operating at 900 nm center wavelength, the GAN621C1 and GAN321C1 systems are designed for high-speed imaging applications requiring very high resolution. The Ganymede systems have an A-scan rate of up to 248 kHz and 106 dB sensitivity at 1.5 kHz.

These Ganymede Series preconfigured OCT system configurations are built completely from components sold in sections located lower on this page. Each preconfigured system includes the three OCT system core components (the base unit, a scanning system with its reference length adapter, and a scan lens kit), as well as two optional accessories (scanner stand and translation stage). For more information about a component included in the preconfigured systems, click on the component description in the table to the lower left to navigate down to the related section on this page.

For information about these systems or to inquire about custom configurations, please contact oct@thorlabs.com.

Preconfigured System Included Components ^a					
System Item #	GAN111C1	GAN311C1	GAN321C1	GAN611C1	GAN621C1
Base Unit	GAN111	GAN311	GAN321	GAN611	GAN621
Scanning System	OCTG9 (Standard Scanner)				
Scan Lens Kit	OCT-LK3-BB	OCT-LK3-BB	OCT-LK2-BB	OCT-LK3-BB	OCT-LK2-BB
Reference Length Adapter	OCT-RA3	OCT-RA3	OCT-RA2	OCT-RA3	OCT-RA2
Accessories: Stand and Stage	OCT-STAND ^b (Scanner Stand) and OCT-XYR1 ^b (Translation Stage)				

a. Click on the component description to navigate down to the related section on this page.

b. Preconfigured systems with metric stands and stages are also available. Contact Our OCT Team for more information.

Preconfigured System Key Specifications					
System Item #	GAN111C1	GAN311C1	GAN321C1	GAN611C1	GAN621C1
Center Wavelength	880 nm	930 nm	900 nm	930 nm	900 nm
Imaging Depth (Air/Water)	3.4 mm / 2.5 mm	2.9 mm / 2.2 mm	1.9 mm / 1.4 mm	2.9 mm / 2.2 mm	1.9 mm / 1.4 mm
Axial Resolution (Air/Water)	6.0 μm / 4.5 μm	5.5 μm / 4.1 μm	3.0 μm / 2.2 μm	5.5 μm / 4.1 μm	3.0 μm / 2.2 μm
Lateral Resolution	8.0 μm	8.0 μm	4.0 μm	8.0 μm	4.0 μm

Preconfigured System Key Specifications

A-Scan/Line Rate	1.5 - 20 kHz ^a	1.5 - 80 kHz ^b	5 - 248 kHz ^c
Sensitivity (Max)^d	106 dB (at 1.5 kHz)	106 dB (at 1.5 kHz)	102 dB (at 5 kHz)

- a. Four Discrete A-Scan Rates: 1.5 kHz, 5 kHz, 10 kHz, and 20 kHz
- b. Six Discrete A-Scan Rates: 1.5 kHz, 5 kHz, 10 kHz, 20 kHz, 40 kHz, and 80 kHz
- c. Seven Discrete A-Scan Rates: 5 kHz, 10 kHz, 25 kHz, 50 kHz, 100 kHz, 200 kHz, and 248 kHz
- d. Typical Values Measured Using a Scanner with a Common Reference/Sample Path and 50% Path Split

Part Number	Description	Price	Availability
GAN111C1	Spectral Domain OCT System, 880 nm, 6.0 µm Resolution, 1.5 to 20 kHz	\$47,353.93	Lead Time
GAN311C1	Spectral Domain OCT System, 930 nm, 5.5 µm Resolution, 1.5 to 80 kHz	\$58,015.26	Lead Time
GAN321C1	Spectral Domain OCT System, 900 nm, 3.0 µm Resolution, 1.5 to 80 kHz	\$63,851.76	Lead Time
GAN611C1	Spectral Domain OCT System, 930 nm, 5.5 µm Resolution, 5 to 248 kHz	\$66,224.04	Lead Time
GAN621C1	Spectral Domain OCT System, 900 nm, 3.0 µm Resolution, 5 to 248 kHz	\$74,330.76	Lead Time

OCT Base Units (Required OCT System Component)

- ▶ Flexibility in Imaging Speed with High- and Very-High-Resolution Performance Options
- ▶ Systems with up to 248 kHz A-Scan Rate (See Table Below)
- ▶ Fully Configurable Trigger for Integration into Larger Experiments
- ▶ Analog Input for Combining Other Data Sources with the OCT Signal
- ▶ Internal Hardware Diagnostics for Improved Troubleshooting

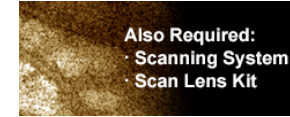

To be functional, an OCT system build must include a base unit, a scanning system, and a scan lens kit.

The imaging performance of any OCT system is largely dependent on the design and components incorporated into the base unit. All of Thorlabs' OCT Base Units include an OCT engine, high-performance computer, pre-installed software, and a software development kit (SDK). For a fully operational system, a scanning system and a scan lens kit (sold separately below) must be purchased with the base unit.

The engines of the Ganymede™ Series OCT Base Units each consist of a superluminescent diode light source, scanning electronics, and a linear CCD array-based spectrometer for detection. The camera built into the Ganymede series base units features both high speed and high sensitivity, providing high A-Scan rates from 1.5 kHz to 248 kHz, with corresponding sensitivities ranging from 106 dB to 84 dB. The engine and detection components are integrated into a 411.8 mm x 325.0 mm x 143.0 mm (16.21" x 12.80" x 5.63") enclosure.

For synchronization with other experiments, two analog inputs are included on the base units; this allows other data sources to be combined or overlaid with the OCT signal. The OCT base units also feature a fully configurable trigger that is extensively programmable in our ThorImage®OCT software. The trigger can be operated as either an input, responding to external signals, or an output, generating trigger signals. Trigger signals can be sent at the start of each A-, B-, or volume scan, as well as after an arbitrary number of scans.

High-Resolution Imaging Base Units

Integrated into Thorlabs' GAN111 base unit is a 880 nm superluminescent laser diode (SLD) with over 70 nm of optical bandwidth, enabling the unit to have high imaging depth and axial resolution in air of 3.4 mm and 6.0 μm, respectively. The GAN311 and GAN611 base units contain a 930 nm SLD providing over 100 nm of spectral bandwidth. The SLD allows the base units to achieve high imaging depth of 2.9 mm and axial resolution of 5.5 μm in air. The GAN311 and GAN611 units allow for A-scan rates of up to 80 kHz and 248 kHz, respectively.

Very-High-Resolution Imaging Base Units

The GAN321 and GAN621 very-high-resolution base units feature Thorlabs' highest resolution OCT imaging capability at a center wavelength of 900 nm. Utilizing a matched pair of superluminescent diodes, it boasts over 150 nm of bandwidth that translates to 3.0 μm axial resolution and an imaging depth of 1.9 mm in air. The GAN321 and GAN621 units allow for A-scan rates of up to 80 kHz and 248 kHz, respectively. These base units are the ideal choice for high-resolution imaging in scattering samples.

Computer Specifications ^a			
Base Unit Item #	GAN111	GAN3x1	GAN6x1
Operating System	Windows 10, 64 Bit		
Processor	4 Core, 3.6 GHz	8 Core, 3.0 GHz	
Memory	16 GB	32 GB	
Hard Drive	256 GB SSD	512 GB SSD	
Data Acquisition	USB 3.0	USB 3.0	CameraLink

a. Computer Specifications Subject to Change

Base Unit Item #	GAN111	GAN311	GAN321	GAN611	GAN621
Description	High Resolution	High Resolution	Very High Resolution	High Resolution	Very High Resolution
Center Wavelength	880 nm	930 nm	900 nm	930 nm	900 nm
Imaging Depth (Air/Water)	3.4 mm / 2.5 mm	2.9 mm / 2.2 mm	1.9 mm / 1.4 mm	2.9 mm / 2.2 mm	1.9 mm / 1.4 mm

Base Unit Item #	GAN111	GAN311	GAN321	GAN611	GAN621
Axial Resolution (Air/Water)	6.0 µm / 4.5 µm	5.5 µm / 4.1 µm	3.0 µm / 2.2 µm	5.5 µm / 4.1 µm	3.0 µm / 2.2 µm
A-Scan Line Rate	1.5, 5, 10, & 20 kHz	1.5, 5, 10, 20, 40, & 80 kHz		5, 10, 25, 50, 100, 200, & 248 kHz	
Sensitivity^a	96 dB (at 20 kHz) to 106 dB (at 1.5 kHz)	89 dB (at 80 kHz) to 106 dB (at 1.5 kHz)		84 dB (at 248 kHz) to 102 dB (at 5 kHz)	
Maximum Pixels per A-Scan	1024				
Compatible Scanners	OCTP-900, OCTP-900/M, OCTG9, and OCTH-900				

a. Typical Values Measured Using a Scanner with a Common Reference/Sample Path and 50% Path Split

Part Number	Description	Price	Availability
GAN111	Ganymede OCT Base Unit, 880 nm, 6.0 µm Resolution, 1.5 to 20 kHz	\$29,169.61	Lead Time
GAN311	Ganymede OCT Base Unit, 930 nm, 5.5 µm Resolution, 1.5 to 80 kHz	\$39,826.64	Lead Time
GAN321	Ganymede OCT Base Unit, 900 nm, 3.0 µm Resolution, 1.5 to 80 kHz	\$44,991.56	Lead Time
GAN611	Ganymede OCT Base Unit, 930 nm, 5.5 µm Resolution, 5 to 248 kHz	\$47,955.34	Lead Time
GAN621	Ganymede OCT Base Unit, 900 nm, 3.0 µm Resolution, 5 to 248 kHz	\$55,376.99	Lead Time

Scanning Systems (Required OCT System Component)

- ▶ Scan an OCT Light Source Beam Across a Sample to Acquire 2D or 3D Images
- ▶ Three Available Options
 - ▶ Standard Scanner for High Stability and Ease-of-Use
 - ▶ User-Customizable Scanners with Open Construction for Customization of Scan Path
 - ▶ Portable Handheld Scanner for Applications Requiring High Mobility

Thorlabs' OCT Scanning Systems are designed to scan the OCT light source beam across a sample for 2D cross-sectional and 3D volumetric imaging.

OCT applications can vary widely, from live animal imaging to industrial materials analysis, with each requiring a different set of scanning parameters. We currently offer three types of beam scanning systems for use with our Ganymede Base Units: standard, user-customizable, and handheld.

Each scanner contains an OCT interferometer with a sample arm and a reference arm. The reference arm of the OCT interferometer is placed near the sample and housed within the scanning system itself to guarantee the phase stability of the sample arm relative to the reference arm. To account for different sample distances and reflectivities (e.g., while imaging through water), the reference arm path length, as well as the reference arm intensity, is adjustable. To

minimize image distortion caused by dispersion, our OCT systems are designed to optically match the reference and sample arm lengths to the greatest extent possible. Dispersion effects from the sample (e.g., imaging through water or glass) can be compensated for using the included ThorImage®OCT software. For customers interested in dual-path setups, any of these scanners can be configured without a beamsplitter; please contact oct@thorlabs.com for more information.

All scanners are equipped with an integrated camera that can obtain real-time *en face* video of the sample during OCT measurements when used with our ThorImageOCT software (see the *Software* tab for details). Illumination of the sample is provided by a ring of user-adjustable white light LEDs around the exit aperture of each scanner.

Standard Scanner

The OCTG9 Standard Scanner is ideal for imaging applications that require a stable, easy-to-operate setup. The entire design of the standard scanner is contained within a rugged, light-tight housing that minimizes the risk of misalignment. For precise measurements and fine adjustments of the reference arm length, a micrometer screw is located at the top of the standard scanner. A reference length adapter, which must be purchased separately, is required for this scanner.

User-Customizable Scanner

The OCTP-900(/M) User-Customizable Scanner is designed with an open construction to enable easy customization of the optical beam path using Thorlabs' standard optomechanical components. This scanner features SM1 (1.035"-40) ports and 4-40 tapped holes at several locations that allow mounting of SM1-threaded or 30 mm cage-compatible components, respectively. The scan lens port is directly compatible with either M25 x 0.75 or SM1-threaded components, and can be converted to other thread standards, such as RMS (0.800"-36) via our selection of thread adapters. Additional scanning and non-scanning optical input/output ports are available for integration of a laser for fluorescence excitation or additional sample illumination.

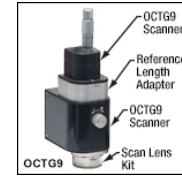

Click for Details
Standard OCT Scanner with Scan Lens Kit and Reference Length Adapter (Not Included)



Click to Enlarge
User-Customizable OCT Scanner



Click to Enlarge
Handheld OCT Scanner

Scanner Type	Item #	Compatible Base Units
Standard Scanner ^a	OCTG9	GAN111 GAN311
User-Customizable Scanner	OCTP-900(/M)	GAN321
Handheld Scanner ^b	OCTH-900	GAN611 GAN621

a. Standard Scanner Requires Purchase of Reference Length Adapter

b. Sample Z-Spacers Recommended When Using OCTH-900

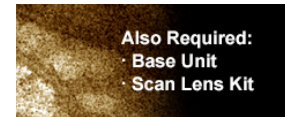

To be functional, an OCT system build must include a base unit, a scanning system, and a scan lens kit.



Click to Enlarge
OCTH-900 Handheld Scanner with OCTH-AIR30 Sample Z-Spacer

Compact Handheld Scanner

The compact and lightweight OCTH-900 Handheld Scanner is specifically designed for applications requiring high mobility. Easy access buttons located directly on the scanner enable fingertip control of our ThorImageOCT Software. Users can program each button from a selection of imaging and acquisition software controls and the software uses visual and audio feedback for button presses. The OCTH-900 features a removable cover under the handle that provides access to the reference length and intensity settings. Compatible scan lens kits and sample z-spacers for the OCTH-900 are sold below; z-spacers help maintain the correct working distance when using the handheld scanner. Please note that due to the limitations of the internal MEMS scanner, the frame rate (i.e., B-Scan rate) is limited to 25 frames per second when using the handheld scanner.

Part Number	Description	Price	Availability
OCTP-900/M	Customer Inspired! User-Customizable Scanner for 880 nm, 900 nm, or 930 nm SD-OCT Systems, Metric	\$13,701.52	Lead Time
OCTG9	Standard Scanner for 880 nm, 900 nm, or 930 nm SD-OCT Systems	\$13,130.63	Lead Time
OCTH-900	Handheld Scanner for 880 nm, 900 nm, or 930 nm SD-OCT Systems	\$11,303.75	Lead Time
OCTP-900	Customer Inspired! User-Customizable Scanner for 880 nm, 900 nm, or 930 nm SD-OCT Systems, Imperial	\$13,701.52	Lead Time

Scan Lens Kits for 900 nm OCT Systems

- ▶ Telecentric Scan Lenses Provide a Flat Imaging Plane
- ▶ Lens AR Coated for 800 - 1100 nm
- ▶ Scan Lens Kits for Standard / User-Customizable Scanners Include
 - ▶ Telecentric Scan Lens
 - ▶ Illumination Tube
 - ▶ IR Card
 - ▶ Calibration Target
 - ▶ Dispersion Compensation Set
- ▶ Compact Scan Lens Kits Designed for the OCTH-900 Handheld Scanner with Integrated Scan Lens and Illumination Ring

Thorlabs' Scan Lens Kits enable easy exchange of scan lenses in an OCT system, providing the flexibility to tailor imaging resolution or working distance for each application. Based on our line of OCT telecentric scan lenses, these lens kits minimize image distortion without extensive post-image processing and maximize coupling of the light scattered or emitted from the sample surface into the detection system.

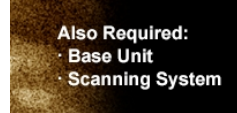

To be functional, an OCT system build must include a base unit, a scanning system, and a scan lens kit.

The cross-section images below of an apple were taken with the OCT-LK2-BB and OCT-LK3-BB scan lens kits using a Ganymede™ Series OCT system. Choose a scan lens kit that provides the right resolution and focal length for your application.

OCT-LK2-BB High Resolution (GAN621)

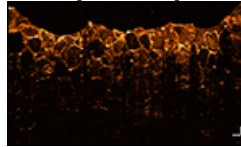

Click to Enlarge
Magnification: 10X
Scan Region: 3 mm x 1.9 mm
Lateral Resolution: 4 μm

OCT-LK3-BB General Purpose (GAN611)

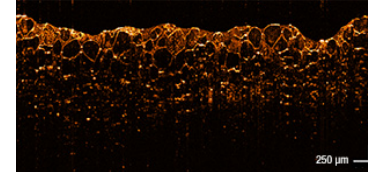

Click to Enlarge
Magnification: 5X
Scan Region: 6 mm x 2.9 mm
Lateral Resolution: 8 μm

As seen in the table below, we offer scan lens kits compatible with the standard (Item # OCTG9) and user-customizable (Item # OCTP-900) scanners, as well as two lens kits compatible with the handheld scanner (Item # OCTH-900).

Each kit includes a telecentric scan lens, illumination tube, IR card, and calibration target. The included illumination tube serves as a light guide that channels light from the LED illumination ring down to the sample area. The IR card and calibration target are provided for calibration of the scanning mirror and lens kit, ensuring the best image quality when swapping between scan lenses.

Scan Lens Kit Item #	OCT-LK2-BB	OCT-LK3-BB	OCT-LK4-BB	OCTH-LK20-BB	OCTH-LK30-BB
Click Image to Enlarge					
Design Wavelength	880 nm / 900 nm / 930 nm / 1060 nm			880 nm / 900 nm / 930 nm	

Scan Lens Kit Item #	OCT-LK2-BB	OCT-LK3-BB	OCT-LK4-BB	OCTH-LK20-BB	OCTH-LK30-BB
Compatible Scanner	OCTG9 (Standard) or OCTP-900 (User-Customizable)			OCTH-900 Handheld Scanner	
Lateral Resolution ^a	4 μm	8 μm	12 μm	9 μm	14 μm
Effective Focal Length	18 mm	36 mm	54 mm	20 mm	30 mm
Working Distance	3.4 mm (with Tube) ^b 7.5 mm (without Tube)	24.9 mm (with Tube) ^b 25.1 mm (without Tube)	41.6 mm (with Tube) ^b 42.3 mm (without Tube)	12 mm	22 mm
Field of View	6 mm x 6 mm	10 mm x 10 mm	16 mm x 16 mm	Ø8 mm	Ø10 mm
Lens Threading	M25 x 0.75	M25 x 0.75	M25 x 0.75	M20 x 0.5 (For Z-Spacer) M14 x 0.5 (For OCTH-900)	

- a. $1/e^2$ Beam Diameter at Focus
b. The illumination tube is user-removable.

Part Number	Description	Price	Availability
OCT-LK2-BB	OCT Scan Lens Kit, 18 mm EFL, 880 nm / 900 nm / 930 nm / 1060 nm	\$2,212.79	Lead Time
OCT-LK3-BB	OCT Scan Lens Kit, 36 mm EFL, 880 nm / 900 nm / 930 nm / 1060 nm	\$1,514.02	Lead Time
OCT-LK4-BB	OCT Scan Lens Kit, 54 mm EFL, 880 nm / 900 nm / 930 nm / 1060 nm	\$1,514.02	Lead Time
OCTH-LK20-BB	OCT Scan Lens Kit for OCTH-900, 20 mm EFL, 880 nm / 900 nm / 930 nm	\$1,152.97	Lead Time
OCTH-LK30-BB	OCT Scan Lens Kit for OCTH-900, 30 mm EFL, 880 nm / 900 nm / 930 nm	\$1,152.97	Lead Time

Reference Length Adapters (Required for Standard Scanners)

- ▶ Arm Adapters for Matching Reference Path Length to the Sample Path Length
- ▶ Use Multiple Reference Adapters for Rapid Switching Between Scan Lens Kits
- ▶ Must be Purchased with Standard Scanner (Item # OCTG9)

Item # ^a	Compatible Scan Lens Kit
OCT-RA2	OCT-LK2-BB
OCT-RA3	OCT-LK3-BB
OCT-RA4	OCT-LK4-BB

These adapters adjust the reference arm path length within the OCTG9 Standard Scanner to match the sample path length of the scan lens used. Choose from three options that are compatible with the scan lens kits sold above. Reference length adapters also enable the user to quickly swap between different scan lens kits without going through extensive adjustments during each switch. The table to the right provides a compatibility list to help select the appropriate reference adapters.

- a. Multiple reference adapters can be purchased for rapid switching between scan lens kits.

Part Number	Description	Price	Availability
OCT-RA2	Length Adapter for SD-OCT Standard Scanner & OCT-LK2(-BB) Scan Lens Kit	\$593.96	Lead Time
OCT-RA3	Length Adapter for SD-OCT Standard Scanner & OCT-LK3(-BB) Scan Lens Kit	\$593.96	7-10 Days
OCT-RA4	Length Adapter for SD-OCT Standard Scanner & OCT-LK4(-BB) Scan Lens Kit	\$593.96	Lead Time

Sample Z-Spacers (Optional Accessories)



Click to Enlarge Z-Spacers for the OCTG9 and OCTP-900(/M) Scanners



Click to Enlarge Z-Spacers for the OCTH-900 Handheld Scanner

- ▶ Sample Z-Spacers Position Scanner at Optimal Working Distance From Sample
- ▶ Ring (Air) and Immersion (Liquid) Z-Spacers Available
- ▶ Two Z-Spacers Recommended for Use with OCTH-900 Handheld Scanner

Thorlabs offers both ring and immersion style sample Z-spacers that enable optimal positioning of a scanning system relative to the sample. The OCT-AIR3, OCT-IMM3, and OCT-IMM4 Z-Spacers feature knurled rings that allow the spacing distance to be adjusted and locked in place for increased stability. Several Z-spacer options are available; please see the table below for compatibility with our scanners and lens kits.

Additionally, we offer two ring-style Z-spacers that are designed specifically for the OCTH-900 Handheld Scanner; these spacers greatly assist in maintaining the correct sample working distance when using the handheld scanner. The spacing distance on the OCTH-AIR20 and OCTH-AIR30 Z-Spacers can be adjusted by rotating the spacer.

Our ring-style Z-spacers provide a distance guide between the scanner and sample. The sample is in contact with the ring-shaped tip of the spacer and should only be used when air is the scanning medium. In contrast, our immersion spacers are equipped with a glass plate that contacts the sample surface within the scanning area. Unlike the ring-style spacers, immersion spacers enable access to samples contained within a liquid environment while also providing sample stabilization. Better index matching and a tilted glass plate also help reduce strong back reflections from the sample surface and enhances the contrast of the image.

Item # ^a	Type	Adjustable	Adjustment Range	Lockable	Compatible Scanner	Compatible Scan Lens Kit
OCT-AIR3	Ring (Air)	Yes	+3.5 mm / -1.0 mm	Yes	OCTG9 OCTP-900(/M)	OCT-LK3-BB
OCT-IMM3	Immersion	Yes	+3.4 mm / -1.1 mm	Yes		OCT-LK4-BB
OCT-IMM4	Immersion	Yes	+1.0 mm / -17.0 mm	Yes		OCTH-LK20-BB
OCTH-AIR20	Ring (Air)	Yes	±4 mm	No	OCTH-900 ^a	OCTH-LK30-BB
OCTH-AIR30	Ring (Air)	Yes	±2 mm	No		

a. We recommend purchasing a sample Z-spacer if using the OCTH-900 handheld scanner.

Part Number	Description	Price	Availability
OCT-AIR3	Ring-Style Sample Z-Spacer for OCT-LK3(-BB) Scan Lens Kit	\$831.55	Lead Time
OCT-IMM3	Immersion-Style Sample Z-Spacer for OCT-LK3(-BB) Scan Lens Kit	\$1,009.74	Lead Time
OCT-IMM4	Immersion-Style Sample Z-Spacer for OCT-LK4(-BB) Scan Lens Kit	\$1,128.52	Lead Time
OCTH-AIR20	Ring-Style Sample Z-Spacer for OCTH-LK20(-BB) Scan Lens Kit	\$214.29	Lead Time
OCTH-AIR30	Ring-Style Sample Z-Spacer for OCTH-LK30(-BB) Scan Lens Kit	\$214.29	Lead Time

Scanner Stand (Optional Accessory)

- ▶ Recommended Stand for Mounting Standard or User-Customizable Scanners
- ▶ Focus Block with Coarse/Fine Z-Axis Travel on Ø1.5" Stainless Steel Post
- ▶ 12" x 14" (300 mm x 350 mm) Aluminum Breadboard with 1/4"-20 (M6) Tapped Holes

For convenient mounting of our Standard or User-Customizable Scanners, we offer a scanner stand that is ideal for use in vibration-sensitive studies such as angiography. It consists of a post-mounted focus block with knobs that provide both coarse (40 mm/rev) and fine (225 µm/rev) z-axis travel. A rotation and height collar underneath the focus block allows it to rotate 45° in order to move the scanner head away from the sample to make adjustments.

The focus block attaches to a 12" x 14" (300 mm x 350 mm) aluminum breadboard via the included Ø1.5" post. The aluminum breadboard has side grips and rubber feet for easy lifting and transportation. There is an array of 1/4"-20 (M6) tapped holes for mounting optomechanics. Four extra 1/4"-20 (M6) tapped holes allow the mounting of the OCT-XYR1 Translation Stage (sold below) to the OCT-STAND and the OCT-XYR1/M Translation Stage to the OCT-STAND/M directly underneath the scan lens. A 1/4"-20 (M6) counterbore is also provided for securing the Ø1.5" post.

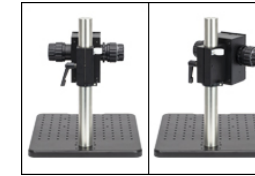

[Click for Details](#)
The focus block can be rotated 45° to move the scanner head away from the sample.

Part Number	Description	Price	Availability
OCT-STAND/M	Stand for Standard and User-Customizable OCT Scanning Systems, M6 Tapped Holes	\$2,329.27	Today
OCT-STAND	Stand for Standard and User-Customizable OCT Scanning Systems, 1/4"-20 Tapped Holes	\$2,329.27	Today

Translation Stage (Optional Accessory)

- ▶ Optional Translation Stage with 0.5" (13 mm) of XY Travel and 360° Rotation
- ▶ Includes Cover Plate for Sample Mounting
- ▶ Can Mount Optomechanics by Removing Cover Plate

Specifications	
Horizontal Load Capacity (Max)	10 lbs (4.5 kg)
Mounting Platform Dimensions	Ø4.18" (Ø106 mm)
Stage Height	1.65" (41.8 mm)
Linear Translation Range	1/2" (13 mm)
Travel per Revolution	0.025" (0.5 mm)
Graduation	0.001" (10 µm) per Division



Click to Enlarge
The cover plate is removable for access to tapped holes and the SM1-threaded central hole.

Precise translation and rotation are often required for optimal positioning of a sample before and during OCT imaging. The OCT-XYR1(/M) is an XY linear translation stage with a rotating platform and solid plate for sample mounting and easy cleaning. The OCT-XYR1 or OCT-XYR1/M stage can be secured to the OCT-STAND or OCT-STAND/M, respectively, using the 1/4" (M6) counterbores at the corners. The top plate is removable for access to 4-40, 8-32 (M4), and 1/4"-20 (M6) tapped holes and an SM1-threaded (1.035"-40) central hole for mounting optomechanical components. The XYR1A Solid Sample Plate can be purchased separately as a direct replacement for the top plate.

The X and Y micrometers offer 1/2" (13 mm) of travel with graduations every 0.001" (10 µm). The stage's rotation and translation can be freely changed without compromising the stability of attached components. An engraved angular scale along the outer edge of the stage's rotating platform allows the user to set the angular orientation of the stage, which can then be fixed using the 5/64" (2 mm) hex locking setscrew. Locking the rotation of the stage does not prevent XY translation using the actuators.

Part Number	Description	Price	Availability
OCT-XYR1/M	XY Stage with Solid Top Plate, 13 mm Travel, 360° Rotation, Metric Taps	\$831.55	7-10 Days
OCT-XYR1	XY Stage with Solid Top Plate, 1/2" Travel, 360° Rotation, Imperial Taps	\$831.55	Today

