

MPSH - July 15, 2022

Item # MPSH was discontinued on July 15th, 2022. For informational purposes, this is a copy of the website content at that time and is valid only for the stated product.

RIGID STANDS

- ▶ Height-Adjustable Stands with 360° Rotation
- ▶ Mount Samples & Experimental Apparatuses
- ▶ Compatible with Upright or Inverted Microscopes



MP200
Rigid Stand with Platform



Application Idea
MZS500-E Z-Axis Piezo Stage Mounted Using an MP100-MLSH Stand with Insert



MP200-RCH2 Adjustable Stand Shown Holding a Microscope Slide Between an Objective and Condenser

[Hide Overview](#)

OVERVIEW

Features

- Rigid Stands Hold Samples or Experimental Apparatuses Underneath and Around the Objective
- Designed for Slides, Petri Dishes, Recording Chambers, Micromanipulators, Well Plates, and DIY Inserts
- Suitable for Upright and Inverted Microscopes
- Base Plate Features Four Slots for 1/4"-20 (M6) Cap Screws for Table Mounting
- Four Versions Support Heights from 5.83" to 20.11" (148.1 mm to 510.9 mm)
- Red Post Holders Compatible with 66 mm Rail Accessories and Mounts
- Translation Stages Available Separately

Thorlabs' Adjustable Rigid Stands provide additional flexibility and adaptability to any microscopy application. Each stand has a slim profile that consumes a minimal amount of space in and around the optical path. This leaves ample approach room for any objectives, micromanipulators, a condenser, and other equipment, making it easy to work around the setup. Additionally, with versions designed for slides, petri dishes, recording chambers, micromanipulators, well plates, and general electrophysiology applications, our rigid stands can be used in virtually any setup.

Each rigid stand provides 360° rotational adjustment allowing a mounted component to be easily positioned within the imaging system. As shown by the table above, the stands are offered in four versions that together support heights from 5.83" to 20.11" (148.1 mm to 510.9 mm), measured from the bottom of the base to the top of the platform.

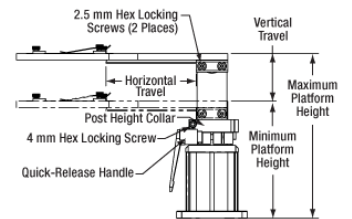

Click to Enlarge
Rigid Stand Operation Diagram
(Slide Holder Stand Shown)





Item # Prefix	Platform/Holder Height ^a	
	Min	Max
MP100	5.83" (148.1 mm)	8.21" (208.5 mm)
MP150	7.80" (198.1 mm)	12.18" (309.3 mm)
MP200	9.77" (248.1 mm)	16.14" (410.1 mm)
MP250	11.74" (298.1 mm)	20.11" (510.9 mm)



a. Measured from Table Top to Platform Surface

As illustrated by the animation to the right, a quick-release clamp locks and unlocks the included post. The included post collar with an alignment pin can be used to maintain the post's height during its rotation. The alignment pin acts as a hard mechanical stop that lets you quickly return to a previously set angle. To raise or lower the post within its given vertical range, it is necessary to loosen the collar, which is locked onto the post using a cap screw that accepts a 4 mm (5/32") balldriver. Each post is housed inside a red post holder, which is compatible with 66 mm rail accessories and optomechanical mounts.

We also offer two types of manual translation stages that provide 25 mm of translation in one or two horizontal axes and are compatible with our rigid stands via the MPA1(M) adapter plate. The manual stages with quick connect feature dovetails that allow users to construct their own multi-axis stage, while the self-contained manual stages offer a more compact footprint. Thorlabs also manufactures motorized translation stages for these rigid stands that enable 1" of horizontal travel in one or two axes.

For sample holders that attach directly to the DIY Cerna® microscope body, please see our manual and motorized XY stages.

Quick Links				
				
Tapped Platforms	Recording Chamber Holders	Slide Holders	Insert Holders	Post Holders

Selection Guide for Rigid Stand Translation Stages		
		
Manual Stages with Quick Connect	Self-Contained Manual Stages	Motorized Stages

[Hide Cerna Videos](#)

CERNA VIDEOS

Building a Cerna® Microscope

The Cerna microscopy platform's large working volume and system of dovetails make it straightforward to connect and position the components of the microscope. This flexibility enables simple and stable set up of a preconfigured microscope, and provides easy paths for later upgrades and modification. See below for a couple examples of the assembly of some DIY Cerna microscopes.

DIY Cerna Design and Assembly

[Hide Microscope Guide](#)

MICROSCOPE GUIDE

Elements of a Microscope

This overview was developed to provide a general understanding of a Cerna® microscope. Click on the different portions of the microscope graphic to the right or use the links below to learn how a Cerna microscope visualizes a sample.

Click on the different parts of the microscope to explore their functions.

- Terminology
- Microscope Body
- Illumination
- Sample Viewing/Recording
- Sample/Experiment Mounting

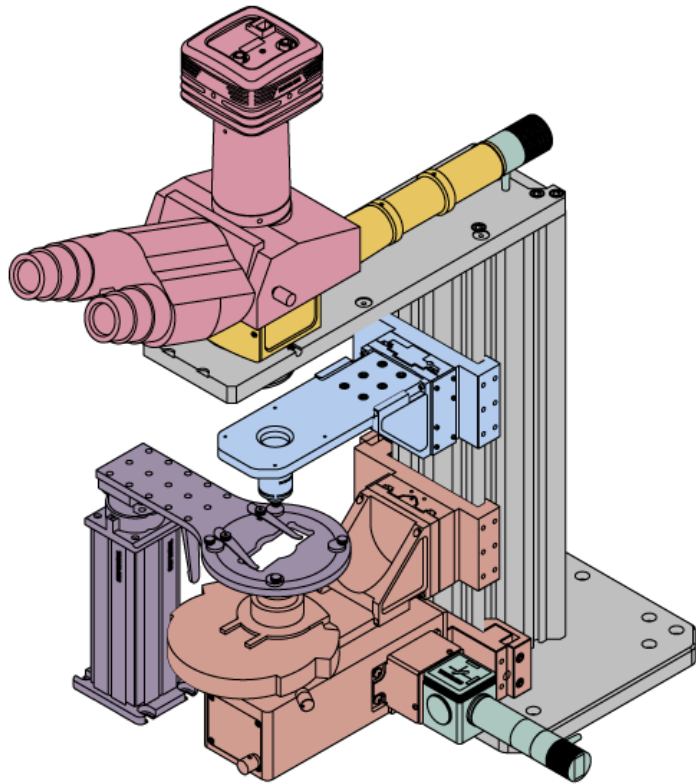

Terminology

Arm: Holds components in the optical path of the microscope.

Bayonet Mount: A form of mechanical attachment with tabs on the male end that fit into L-shaped slots on the female end.

Bellows: A tube with accordion-shaped rubber sides for a flexible, light-tight extension between the microscope body and the objective.

Breadboard: A flat structure with regularly spaced tapped holes for DIY construction.

Dovetail: A form of mechanical attachment for many microscopy components. A linear dovetail allows flexible positioning along one dimension before being locked down, while a circular dovetail secures the component in one position. See the *Microscope Dovetails* tab or here for details.

Epi-Illumination: Illumination on the same side of the sample as the viewing apparatus. Epi-fluorescence, reflected light, and confocal microscopy are some examples of imaging modalities that utilize epi-illumination.

Filter Cube: A cube that holds filters and other optical elements at the correct orientations for microscopy. For example, filter cubes are essential for fluorescence microscopy and reflected light microscopy.

Köhler Illumination: A method of illumination that utilizes various optical elements to defocus and flatten the intensity of light across the field of view in the sample plane. A condenser and light collimator are necessary for this technique.

Nosepiece: A type of arm used to hold the microscope objective in the optical path of the microscope.

Optical Path: The path light follows through the microscope.

Rail Height: The height of the support rail of the microscope body.

Throat Depth: The distance from the vertical portion of the optical path to the edge of the support rail of the microscope body. The size of the throat depth, along with the working height, determine the working space available for microscopy.

Trans-Illumination: Illumination on the opposite side of the sample as the viewing apparatus. Brightfield, differential interference contrast (DIC), Dodt gradient contrast, and darkfield microscopy are some examples of imaging modalities that utilize trans-illumination.

Working Height: The height of the support rail of the microscope body plus the height of the base. The size of the working height, along with the throat depth, determine the working space available for microscopy.

Microscope Body

The microscope body provides the foundation of any Cerna microscope. The support rail utilizes 95 mm rails machined to a high angular tolerance to ensure an aligned optical path and perpendicularity with the optical table. The support rail height chosen (350 - 600 mm) determines the vertical range available for experiments and microscopy components. The 7.74" throat depth, or distance from the optical path to the support rail, provides a large working space for experiments. Components attach to the body by way of either a linear dovetail on the support rail, or a circular dovetail on the epi-illumination arm (on certain models). Please see the *Microscope Dovetails* tab or here for further details.

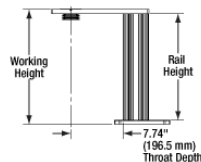

Click to Enlarge
Body Details

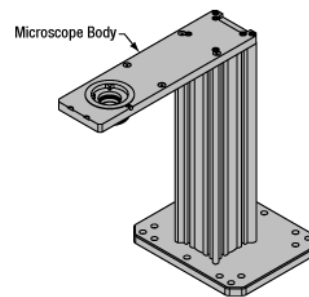

Click to
Enlarge
Cerna Microscope Body

	
Microscope Bodies	Microscope Translator

Illumination

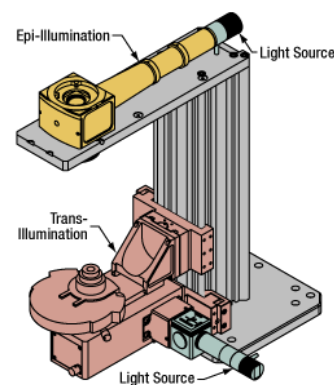

Using the Cerna microscope body, a sample can be illuminated in two directions: from above (epi-illumination, see yellow components to the right) or from below (trans-illumination, see orange components to the right).

Epi-illumination illuminates on the same side of the sample as the viewing apparatus; therefore, the light from the illumination source (green) and the light from the sample plane share a portion of the optical path. It is used in fluorescence, confocal, and reflected light microscopy. Epi-illumination modules, which direct and condition light along the optical path, are attached to the epi-illumination arm of the microscope body via a circular D1N dovetail (see the *Microscope Dovetails* tab or here for details). Multiple epi-illumination modules are available, as well as breadboard tops, which have regularly spaced tapped holes for custom designs.



Click to
Enlarge
Illumination with a Cerna microscope can come from above (yellow) or below (orange). Illumination sources (green) attach to either.

Trans-illumination illuminates from the opposite side of the sample as the viewing apparatus. Example imaging modalities include brightfield, differential interference contrast (DIC), Dodt gradient contrast, oblique, and darkfield microscopy. Trans-illumination modules, which condition light (on certain models) and direct it along the optical path, are attached to the support rail of the microscope body via a linear dovetail (see *Microscope Dovetails* tab or here). Please note that certain imaging modalities will require additional optics to alter the properties of the beam; these optics may be easily incorporated in the optical path via lens tubes and cage systems. In addition, Thorlabs offers condensers, which reshape input collimated light to help create optimal Köhler illumination. These attach to a mounting arm, which holds the condenser at the throat depth, or the distance from the optical path to the support rail. The arm attaches to a focusing module, used for aligning the condenser with respect to the sample and trans-illumination module.

							
Epi-Illumination Modules	Breadboards & Body Attachments	Brightfield	DIC	Dodt	Condensers	Condenser Mounting	Light Sources

Sample Viewing/Recording

Once illuminated, examining a sample with a microscope requires both focusing on the sample plane (see blue components to the right) and visualizing the resulting image (see pink components).

A microscope objective collects and magnifies light from the sample plane for imaging. On the Cerna microscope, the objective is threaded onto a nosepiece, which holds the objective at the throat depth, or the distance from the optical path to the support rail of the microscope body. This nosepiece is secured to a

motorized focusing module, used for focusing the objective as well as for moving it out of the way for sample handling. To ensure a light-tight path from the objective, the microscope body comes with a bellows (not pictured).

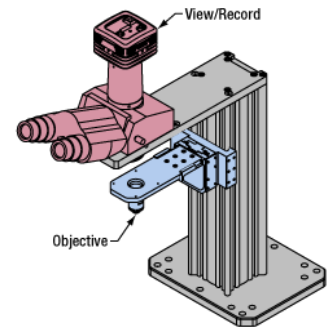

Click to

Various modules are available for sample viewing and data collection. Trinoculars have three points of vision to view the sample directly as well as with a camera. Double camera ports redirect or split the optical path among two viewing channels. Camera tubes increase or decrease the image magnification. For data collection, Thorlabs offers both cameras and photomultiplier tubes (PMTs), the latter being necessary to detect fluorescence signals for confocal microscopy. Breadboard tops provide functionality for custom-designed data collection setups. Modules are attached to the microscope body via a circular dovetail (see the *Microscope Dovetails* tab or here for details).

Enlarge
Light from the sample plane is collected through an objective (blue) and viewed using trinocs or other optical ports (pink).

Objectives & Accessories	Objective Mounting	Sample Viewing	Cameras	PMTs	Breadboards & Body Attachments

Sample/Experiment Mounting

Various sample and equipment mounting options are available to take advantage of the large working space of this microscope system. Large samples and ancillary equipment can be mounted via mounting platforms, which fit around the microscope body and utilize a breadboard design with regularly spaced tapped through holes. Small samples can be mounted on rigid stands (for example, see the purple component to the right), which have holders for different methods of sample preparation and data collection, such as slides, well plates, and petri dishes. For more traditional sample mounting, slides can also be mounted directly onto the microscope body via a manual XY stage. The rigid stands can translate by way of motorized stages (sold separately), while the mounting platforms contain built-in mechanics for motorized or manual translation. Rigid stands can also be mounted on top of the mounting platforms for independent and synchronized movement of multiple instruments, if you are interested in performing experiments simultaneously during microscopy.

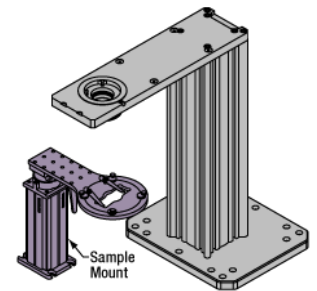

Click to

Enlarge
The rigid stand (purple) pictured is one of various sample mounting options available.

Close

Translating Platforms	Rigid Stands	Translation Stages for Rigid Stands	Motorized XY Stages	Manual XY Stage

For sample viewing, Thorlabs offers trinoculars, double camera ports, and camera tubes. Light from the sample plane can be collected via cameras, photomultiplier tubes (PMTs), or custom setups using breadboard tops. Click here for additional information about viewing samples with a Cerna microscope.

Product Families & Web Presentations

Sample Viewing	Breadboards & Body	Cameras	PMTs

Microscope objectives are held in the optical path of the microscope via a nosepiece. Click here for additional information about viewing a sample with a Cerna microscope.

Product Families & Web Presentations



Objectives



Objective Thread
Adapters



Parfocal Length
Extender



Piezo Objective
Scanner



Objective Mounting

Large and small experiment mounting options are available to take advantage of the large working space of this microscope. Click here for additional information about mounting a sample for microscopy.

Product Families & Web Presentations



Translating
Platforms



Rigid Stands



Translation Stages
for Rigid Stands



Motorized XY
Stages



Manual XY Stage

Thorlabs offers various light sources for epi- and trans-illumination. Please see the full web presentation of each to determine its functionality within the Cerna microscopy platform.

Product Families & Web Presentations



Trans-Illumination
Kits



Solis™ High-
Power LEDs



Mounted LEDs



X-Cite® Lamps



Other Light
Sources

Epi-illumination illuminates the sample on the same side as the viewing apparatus. Example imaging modalities include fluorescence, confocal, and reflected light microscopy. Click here for additional information on epi-illumination with Cerna.

Product Families & Web Presentations



Epi-Illumination



Body Attachments



Light Sources

Close

Trans-illumination illuminates from the opposite side of the sample as the viewing apparatus. Example imaging modalities include brightfield, differential interference contrast (DIC), Dodt gradient contrast, oblique, and darkfield microscopy. Click here for additional information on trans-illumination with Cerna.

Product Families & Web Presentations

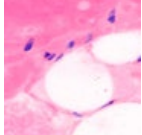

Brightfield

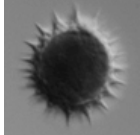

DIC

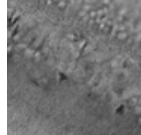

Dodt



Condensers



Condenser Mounting



Illumination Kits



Other Light Sources

Close

The microscope body provides the foundation of any Cerna microscope. The 7.74" throat depth provides a large working space for experiments. Click here for additional information about the Cerna microscope body.

Product Families & Web Presentations



Microscope Bodies



Microscope Translator

[Hide Rigid Stands with Platform](#)

Rigid Stands with Platform

- ▶ 200.0 mm x 58.9 mm Platform for Holding Micromanipulators or Other Equipment
- ▶ 24 M6 x 1.0 Tapped Holes at 25 mm Spacings for Increased Mounting Options
- ▶ Quick-Release Clamp Enables Tool-Free Positioning
- ▶ Collar Provides Stops at User-Specified Height and Angle
- ▶ Horizontal, Vertical, and Rotational Adjustments Provide Flexible Positioning
- ▶ Maximum Load of 20 lbs at Full Extension
- ▶ Translation Stages for Rigid Stands Available

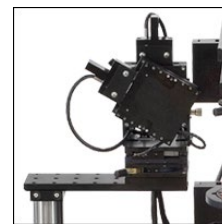

Click for Details
Micromanipulator Shown Mounted on a Rigid Stand with Tapped Platform

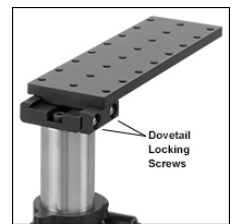

Click for Details
Slidable Dovetail is Locked into Place via Two Locking Screws

These rigid stands provide a 200.0 mm x 58.9 mm Platform with 24 M6 x 1.0 tapped holes at 25 mm spacings for mounting micromanipulators and other experimental equipment at various heights. When the platform is extended fully (i.e., both dovetail locking screws can still be engaged), the outermost edge of the platform will support a load of 20 lbs (9 kg).

To allow you to fine tune the location of the mounted equipment, the bottom of the platform has been equipped with a slidable dovetail, as shown by the photo to the right. This dovetail, which is also used in Thorlabs' 66 mm optical rails, is held in place by two screws that accept a 2.5 mm balldriver. Loosening these screws lets the platform translate horizontally over a 6.30" (160.0 mm) range. This long adjustment range also lets the red post holder be positioned over a range of locations on the tabletop.

The base can be secured to a tabletop via four counterbored slots that accept 1/4"-20 (M6) cap screws. The base is also compatible with the MPA1(/M) adapter plate that allows a rigid stand to be mounted on a translation stage.

Part Number	Description	Price	Availability
MP100	Rigid Stand with Platform, Adjustment Height: 148.1 - 208.5 mm	\$647.02	Today
MP150	Rigid Stand with Platform, Adjustment Height: 198.1 - 309.3 mm	\$652.45	Today
MP200	Rigid Stand with Platform, Adjustment Height: 248.1 - 410.1 mm	\$677.46	Today
MP250	Rigid Stand with Platform, Adjustment Height: 298.1 - 510.9 mm	\$692.68	Today

[Hide Rigid Stand Recording Chamber Holders](#)

Rigid Stand Recording Chamber Holders



[Click to Enlarge](#)

- ▶ Holds Ø110 mm Recording Chambers
- ▶ Quick-Release Clamp Enables Tool-Free Positioning
- ▶ Collar Provides Stops at User-Specified Height and Angle
- ▶ Horizontal, Vertical, and Rotational Adjustments Provide Flexible Positioning
- ▶ Slide Holder Inserts Available in Aluminum or Stainless Steel
- ▶ Translation Stages for Rigid Stands Available

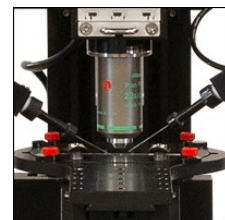

[Click for Details](#)
MP100-RCH1 Recording Chamber Holder with a Custom Insert (Not Included)

These sample holders are designed to let you easily mount a recording chamber at the location you desire in a microscope's optical path. The top platform has a Ø110 mm opening with a 5 mm wide lip and four clamps to securely mount a recording chamber in the optical path. Alternatively, slide holder inserts for mounting a microscope slide (up to 26.0 mm x 76.2 mm) can also be purchased separately and are available in aluminum or stainless steel. The stainless steel insert is useful for applications requiring a magnetic surface for the experimental setup. For custom plate inserts, please contact Technical Support.

Additionally, fifteen M6 x 1.0 tapped holes at 25 mm spacings on top of the platform can be used to mount experimental equipment. The base can be secured to a tabletop via four counterbored slots that accept 1/4"-20 (M6) cap screws. The base is also compatible with the MPA1(/M) adapter plate that allows a rigid stand to be mounted on a translation stage.

To allow you to fine tune the recording chamber's position underneath the objective, the bottom of the platform has been equipped with a slidable dovetail. This dovetail, which is also used in Thorlabs' 66 mm optical rails, is held in place by two screws that accept a 2.5 mm balldriver. Loosening these screws lets the recording chamber translate horizontally over a 4.49" (114.2 mm) range. This long adjustment range also lets the red post holder be positioned over a range of locations on the tabletop.

Part Number	Description	Price	Availability
MP100-RCH1	Recording Chamber Holder, Adjustment Height: 148.1 - 208.5 mm	\$736.19	Today
MP150-RCH1	Recording Chamber Holder, Adjustment Height: 198.1 - 309.3 mm	\$761.20	Today
MP200-RCH1	Recording Chamber Holder, Adjustment Height: 248.1 - 410.1 mm	\$765.54	Today
MP250-RCH1	Recording Chamber Holder, Adjustment Height: 298.1 - 510.9 mm	\$779.69	Lead Time
MPPSH	Slide Holder Insert for Recording Chamber Holder, Aluminum	\$179.43	Lead Time
MPPSHSS	Slide Holder Insert for Recording Chamber Holder, Stainless Steel	\$453.51	Today

[Hide Rigid Stand Slide Holders](#)

Rigid Stand Slide Holders

- ▶ Designed for Microscope Slides Up to 26.0 mm x 76.2 mm
- ▶ Quick-Release Clamp Enables Tool-Free Positioning
- ▶ Collar Provides Stops at User-Specified Height and Angle
- ▶ Horizontal, Vertical, and Rotational Adjustments Provide Flexible Positioning
- ▶ Spring Clips for Holding Petri Dish or Microscope Slides
- ▶ Translation Stages for Rigid Stands Available



[Click to Enlarge](#)
[APPLIST]



[Click for Details](#)
MP100-RCH2 Slide Holder in a
®

These sample holders are designed to let you easily rotate a microscope slide (up to 26.0 mm x

76.2 mm) into and out of the optical path of a Cerna® microscope. Fifteen M6 x 1.0 tapped holes at 25 mm spacings on top of the platform can be used to mount additional experimental equipment. The microscope slide tray is removable by loosening the four red thumbscrews and moving the plate clamps, allowing the sample holder to mount a petri dish or recording chamber instead (see Recording Chamber section above). The MPSH and MPSHSS Slide Holder Inserts (sold above) are compatible with these holders.

[APPLIST]
Using a 66 mm rail carrier, a photodiode power sensor and condenser lens are attached to the post holder of a rigid stand to measure light transmitted through a sample.

DIY Cerna Microscope System

To allow you to fine tune the slide's position underneath the objective, the bottom of the platform has been equipped with a slidable dovetail. This dovetail, which is also used in Thorlabs' 66 mm optical rails, is held in place by two screws that accept a 2.5 mm balldriver. Loosening these screws lets the slide translate horizontally over a 4.49" (114.2 mm) range. This long adjustment range also lets the red post holder be positioned over a range of locations on the tabletop.

The base can be secured to a tabletop via four counterbored slots that accept 1/4"-20 (M6) cap screws. The base is also compatible with the MPA1(/M) adapter plate that allows a rigid stand to be mounted on a translation stage.

Part Number	Description	Price	Availability
MP100-RCH2	Slide Holder, Adjustment Height: 148.1 - 208.5 mm	\$864.51	7-10 Days
MP150-RCH2	Slide Holder, Adjustment Height: 198.1 - 309.3 mm	\$879.73	7-10 Days
MP200-RCH2	Slide Holder, Adjustment Height: 248.1 - 410.1 mm	\$894.95	Today
MP250-RCH2	Slide Holder, Adjustment Height: 298.1 - 510.9 mm	\$909.08	Today

[Hide Rigid Stand Insert Holders and Inserts](#)

Rigid Stand Insert Holders and Inserts

- ▶ Designed for Multiple Slides, Petri Dishes, Our MZS500-E Z-Axis Piezo Stage, Well Plates, and User-Designed Inserts
- ▶ Quick-Release Clamp Enables Tool-Free Positioning
- ▶ Collar Provides Stops at User-Specified Height and Angle
- ▶ Horizontal, Vertical, and Rotational Adjustments Provide Flexible Positioning
- ▶ Translation Stages for Rigid Stands Available



Click to Enlarge
MP100-MLSH Rigid Stand with
MLS203P5 Breadboard Insert



Click to Enlarge
MP100-MLSH Rigid Stand with
MLS203P2 Slide/Petri Dish
Holder

These rigid stands contain a rectangular slot that is compatible with the 6.70" x 5.13" inserts shown below (which are sold separately). These inserts can be used to mount samples or experimental equipment in or near the optical path of the Cerna microscope, enabling a variety of experimental configurations beyond those achievable with our more basic sample holders. Eight M6 x 1.0 tapped holes on top of the platform can be used to mount additional experimental equipment

To allow you to fine tune the location of the insert, the bottom of the platform has been equipped with a slidable dovetail. This dovetail, which is also used in Thorlabs' 66 mm optical rails, is held in place by two screws that accept a 2.5 mm balldriver. Loosening these screws lets the insert translate horizontally over a 2.56" (65.0 mm) range. This long adjustment range also lets the red post holder be positioned over a range of locations on the tabletop.

The base can be secured to a tabletop via four counterbored slots that accept 1/4"-20 (M6) cap screws. The base is also compatible with the MPA1(/M) adapter plate that allows a rigid stand to be mounted on a translation stage.

Compatible Inserts

The inserts in the table below are designed for our Rigid Stand Insert Holders and the MLS203-1 and MLS203-2 Fast XY Scanning Stages.

Slide, Petri Dish, Calibration Target, and Well Plate Holders			
 <p>Click to Enlarge MLS203P2 Slide/Petri Dish Holder</p> <ul style="list-style-type: none"> ▶ Holds One Slide or Petri Dish at a Time <ul style="list-style-type: none"> • Microscope Slides up to 26 mm x 76 mm • Petri Dishes (Ø30 mm to Ø60 mm) 	 <p>Click to Enlarge MLS203P10 Multi-Slide Holder</p> <ul style="list-style-type: none"> ▶ Holds up to Four Microscope Slides at Once <ul style="list-style-type: none"> • Microscope Slides Up to 26 mm x 76 mm 	 <p>Click to Enlarge MLS203P11 Recessed Slide Holder</p> <ul style="list-style-type: none"> ▶ Holds One Slide and One Calibration Target Simultaneously <ul style="list-style-type: none"> • Microscope Slides up to 26 mm x 76 mm • Calibration Targets (18 mm x 18 mm) 	 <p>Click to Enlarge MLS203P1 Multiwell Plate Adapter</p> <ul style="list-style-type: none"> ▶ Mount the C4SH01 Four-Slide Holder and Standard Well Plates ▶ Clip Holder to Secure Samples in Place

▶ Allows Condenser to be within 1.5 mm (0.06") of Slide

Z-Axis Piezo Stage



Click to Enlarge
MZS500-E Z-Axis Piezo Stage

- ▶ 500 μm of Z-Axis Travel with 25 nm Resolution (Canadian Patent #2,812,367)
- ▶ Includes BPC301 Controller
- ▶ Link to Full Web Presentation for More Details and All Compatible Inserts

Holders for User-Designed Inserts



Click to Enlarge
Breadboard

- ▶ Imperial or Metric Tapped Hole Pattern
 - MLS203P5: 35 1/4"-20 Taps at 1" Spacings
 - MLS203P4: 35 M6 x 1.0 Taps at 25 mm Spacings



Click to Enlarge
MLS203P3 Blank Adapter Plate

- ▶ Constructed from Anodized Aluminum
- ▶ Easily Drilled or Tapped in Your Own Machine Shop

Part Number	Description	Price	Availability
MLS203P4	Metric M6 Breadboard Plate	\$226.27	Today
MP100-MLSH	Large Insert Holder, Adjustment Height: 148.1 - 208.5 mm	\$871.80	7-10 Days
MP150-MLSH	Large Insert Holder, Adjustment Height: 198.1 - 309.3 mm	\$886.23	Today
MP200-MLSH	Large Insert Holder, Adjustment Height: 248.1 - 410.1 mm	\$901.75	Today
MP250-MLSH	Large Insert Holder, Adjustment Height: 298.1 - 510.9 mm	\$917.29	Today
MLS203P2	Slide/Petri Dish Holder for Inverted Microscopes	\$509.12	Today
MLS203P10	Multiple Slide Holder for Upright and Inverted Microscopes	\$521.30	Today
MLS203P11	Recessed Slide Holder for Upright Microscopes	\$446.99	Lead Time
MLS203P1	Multiwell Plate Adapter	\$452.54	Today
MZS500-E	Z-Axis Piezo Stage and Controller Kit	\$11,923.59	Today
MLS203P3	Blank Adapter Plate	\$169.70	Today
MLS203P5	Imperial 1/4"-20 Breadboard Plate	\$226.27	Today

[Hide Rigid Stand Post Holders](#)

Rigid Stand Post Holders

- ▶ Empty Post Holder with Included Post Collar
- ▶ Available in Four Heights
- ▶ Accepts $\varnothing 1.5$ " Stainless Steel Posts
- ▶ Compatible with 66 mm Rail Accessories and Mounts
- ▶ Translation Stages for Rigid Stands Available

These are the same red post holders included with the rigid stands sold above. They are available in heights of 100 mm, 150 mm, 200 mm, and 250 mm, as defined by the drawing to the right. Each holder includes the same collar and alignment pin that is provided with each rigid stand.

Additional post holders can be used to save reference positions on the tabletop or safely store sample holders that are not in use. Alternatively, by purchasing a taller post holder than one you already have, the vertical range of your sample holder can be effectively increased. Note, however, that rigid stands with item # prefixes MP100, MP150, MP200, and MP250 come with 100 mm, 150 mm, 200 mm, and 250 mm tall posts, respectively. Therefore, a shorter post holder cannot be used to reduce the platform height of a taller rigid stand.

The base can be secured to a tabletop via four counterbored slots that accept 1/4"-20 (M6) cap screws. The base is also compatible with the MPA1(/M) adapter plate that allows a rigid stand to be mounted on a translation stage. These post holders also accept $\varnothing 1.5$ " stainless steel posts for DIY mounting options.

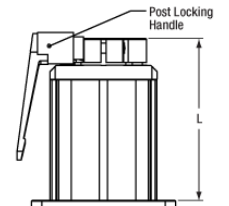

Click to Enlarge
Drawing of Rigid Stand Post Holders

Part Number	Description	Price	Availability
LPH100	Rigid Stand Post Holder, L = 100 mm	\$384.89	7-10 Days
LPH150	Rigid Stand Post Holder, L = 150 mm	\$400.42	Today
LPH200	Rigid Stand Post Holder, L = 200 mm	\$414.83	Today
LPH250	Rigid Stand Post Holder, L = 250 mm	\$430.36	Today

