

56 Sparta Avenue • Newton, New Jersey 07860
 (973) 300-3000 Sales • (973) 300-3600 Fax
 www.thorlabs.com



FDPS3X3 - JUN 25, 2020

Item # FDPS3X3 was discontinued on JUN 25, 2020. For informational purposes, this is a copy of the website content at that time and is valid only for the stated product.

IR PHOTOCONDUCTIVE DETECTORS

- ▶ PbSe and PbS Photoconductive Detectors
- ▶ Linear Response for 1.0 - 2.9 μm or 1.5 - 4.8 μm
- ▶ TO-5 Package Style



OVERVIEW

Lead Sulfide (PbS) and Lead Selenide (PbSe) photoconductors are widely used for the detection of infrared radiation from 1.0 to 4.8 μm . Photoconductors detect light in a broader wavelength range, offer higher detection capability, and provide better linear response in the IR than typical PIN junction photodiodes.

These items will be retired without replacement when stock is depleted. If you require these parts for line production, please contact our OEM Team.

Limited
STOCK

Mounted and Unmounted Detectors
Unmounted Photodiodes (150 - 2600 nm)
Calibrated Photodiodes (350 - 1800 nm)
Mounted Photodiodes (150 - 1800 nm)
Thermopile Detectors (0.2 - 15 μm)
Photoconductors (1 - 4.8 μm)
Photovoltaic Detectors (2.0 - 10.6 μm)
Pigtailed Photodiodes (320 - 1000 nm)

Photoconductors vs. Photodiodes

Unlike PIN junction photodiodes, which generate a photocurrent when light is absorbed in the depleted region of the junction semiconductor, the photoconductive material in these devices exhibits a decrease in electrical resistance when illuminated with IR radiation. Photoconductive detectors typically have a very linear response when illuminated with IR radiation.

Usage Notes

Photoconductors function differently than typical PIN junction photodiodes. We recommend that an optical chopper be employed when using these detectors with CW light, due to signal noise issues. PbS and PbSe detectors can be used at room temperature. However, temperature fluctuations will affect dark resistance, sensitivity, and response speeds (see the Temperature Considerations section in the *Tutorial* tab for details).

GRAPHS

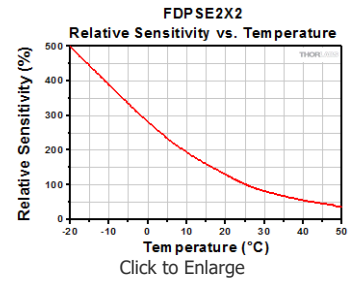
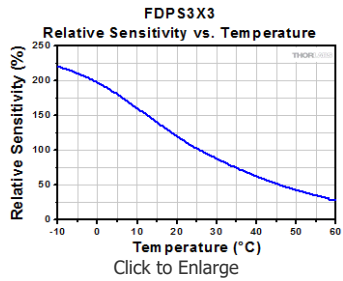
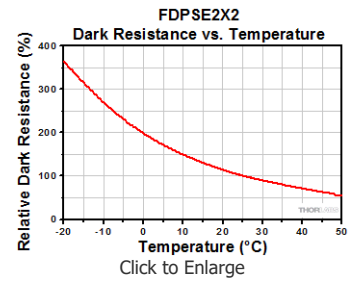
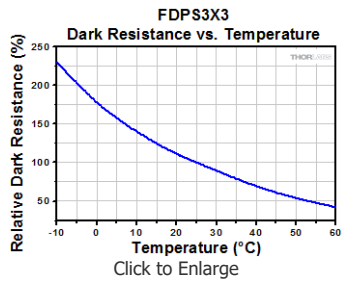
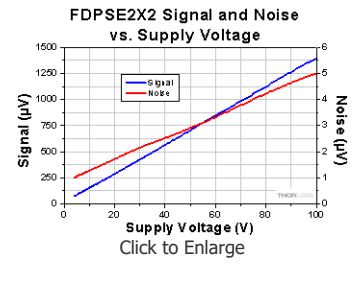
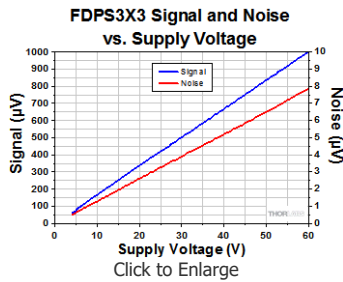
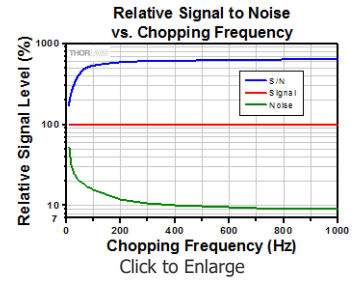
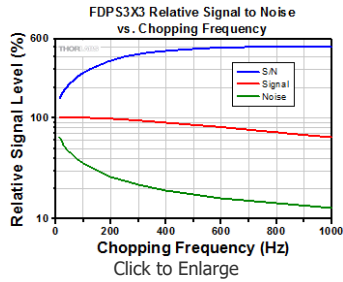
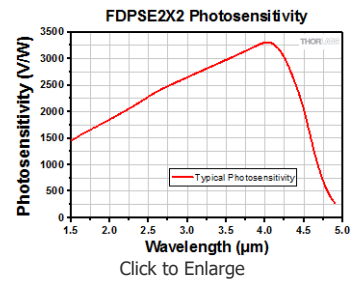
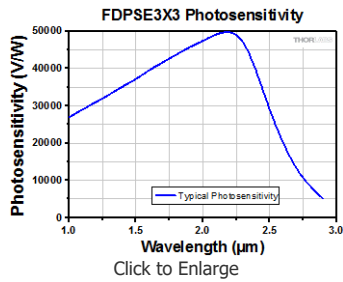

TUTORIAL

PbS and PbSe Photoconductive Detectors

Lead Sulfide (PbS) and Lead Selenide (PbSe) photoconductive detectors are widely used in detection of infrared radiation from 1000 to 4800 nm. Unlike standard photodiodes, which produce a current when exposed to light, the electrical resistance of the photoconductive material is reduced when illuminated with light. Although PbS and PbSe detectors can be used at room temperature, temperature fluctuations will affect dark resistance, sensitivity, and response speeds (see Temperature Considerations below).

Theory of Operation

For photoconductive materials, incident light will cause the number of charge carriers in the active area to increase, thus decreasing the resistance of the detector. This change in resistance leads to a change in measured voltage, and hence, photosensitivity is expressed in units of V/W. An example operating circuit is shown to the right. Please note that the circuit depicted is not recommended for practical purposes since low frequency noise will be present.

The detection mechanism is based upon the conductivity of the thin film of the active area. The output signal of the detector with no incident light is defined by the following equation:

$$V_{OUT} = \frac{R_{LOAD}}{R_{DARK} + R_{LOAD}} * V_{BIAS}$$

A change ΔV_{OUT} then occurs due to a change ΔR_{DARK} in the resistance of the detector when light strikes the active area:

$$\Delta V_{OUT} = - \frac{R_{LOAD} V_{BIAS}}{(R_{DARK} + R_{LOAD})^2} * \Delta R_{DARK}$$

Frequency Response

Photoconductors must be used with a pulsed signal to obtain AC signals. Hence, an optical chopper should be employed when using these detectors with CW light. The detector responsivity (R_f) when using a chopper can be calculated using the equation below:

$$R_f = \frac{R_0}{\sqrt{1 + 4\pi^2 f_c^2 \tau_r^2}}$$

Here, f_c is the chopping frequency, R_0 is the response at 0 Hz, and τ_r is the detector rise time.

Effects of Chopping Frequency

The photoconductor signal will remain constant up to the time constant response limit. PbS and PbSe detectors have a typical 1/f noise spectrum (i.e., the noise decreases as chopping frequency increases), which has a profound impact on the time constant at lower frequencies.

The detector will exhibit lower responsivity at lower chopping frequencies. Frequency response and detectivity are maximized for

$$f_c = \frac{1}{2\pi\tau_r}$$

The characteristic curve for Signal vs. Chopping Frequency for each particular detector is provided in chapter 4 of the operating manuals.

Temperature Considerations

These detectors consist of a thin film on a glass substrate. The effective shape and active area of the photoconductive surface varies considerably based upon the operating conditions, thus changing performance characteristics. Specifically, responsivity of the detector will change based upon the operating temperature.

Temperature characteristics of PbS and PbSe bandgaps have a negative coefficient, so cooling the detector shifts its spectral response range to longer wavelengths. For best results, operate the photodiode in a stable controlled environment. See the Operating Manuals for characteristic curves of Temperature vs. Sensitivity for a particular detector.

Typical Photoconductor Amplifier Circuit

Due to the noise characteristic of a photoconductor, it is generally suited for AC coupled operation. The DC noise present with the applied bias will be too great at high bias levels, thus limiting the practicality of the detector. For this reason, IR detectors are normally AC coupled to limit the noise. A pre-amplifier is required to help maintain the stability and provide a large gain for the generated current signal.

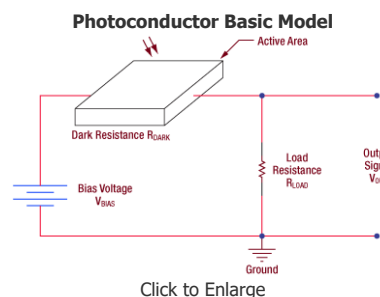

Based on the schematic below, the op-amp will try to maintain point A to the input at B via the use of feedback. The difference between the two input voltages is amplified and provided at the output. It is also important to note the high pass filter that AC couples the input of the amplifier blocks any DC signal. In addition, the resistance of the load resistor (R_{LOAD}) should be equal to the dark resistance of the detector to ensure maximum signal can be acquired. The supply voltage (+V) should be at a level where the SNR is acceptable and near unity. Some applications require higher voltage levels; as a result the noise will increase. Provided in chapter 4 of the Operating Manual is a SNR vs. Supply Voltage characteristic curve to help determine best operating condition. The output voltage is derived as the following:

$$V_{out} = \left(1 + \frac{R_f}{R_i}\right) * I_s R_D$$

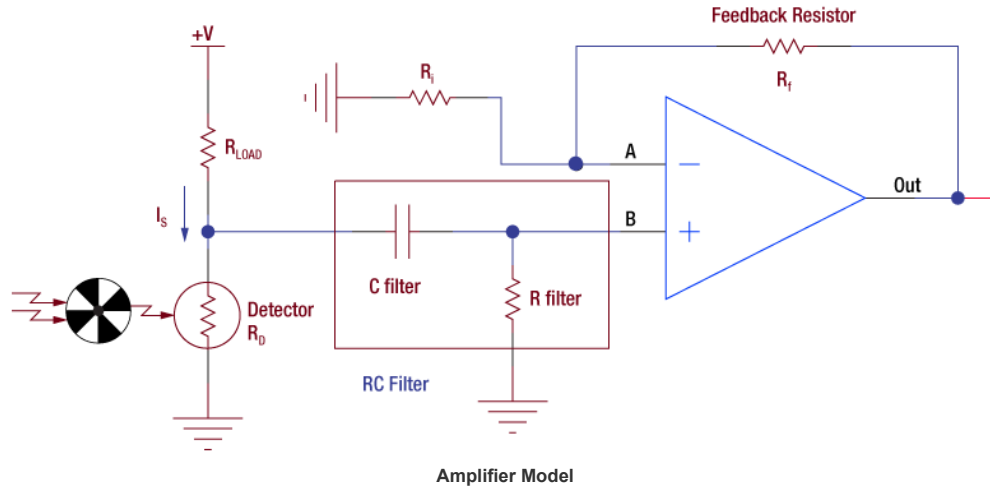

Signal to Noise Ratio

Since the detector noise is inversely proportional to the chopping frequency, the noise will be greater at low frequencies. The detector output signal is linear to increased bias voltage, but the noise shows little dependence on the bias at low levels. When a set bias voltage is reached, the detector noise will increase linearly with applied voltage. At high voltage levels, noise tends to increase exponentially, thus degrading the signal to noise ratio (SNR) further. To yield the best SNR, adjust the chopping frequency and bias voltage to an acceptable level. Provided in chapter 4 of the operating manuals are characteristic curves for SNR vs. Chopping Frequency and SNR vs. Supply Voltage for each particular detector.

Noise Equivalent Power

The noise equivalent power (NEP) is the generated RMS signal voltage generated when the signal to noise ratio is equal to one. This is useful, as the NEP determines the ability of the detector to detect low level light. In general, the NEP increases with the active area of the detector and is given by the following equation:

$$NEP = \frac{\text{Incident Energy} * \text{Area}}{\frac{S}{N} * \sqrt{\Delta f}}$$

Here, S/N is the Signal to Noise Ratio, Δf is the Noise Bandwidth, and Incident Energy has units of W/cm^2 . For more information on NEP, please see Thorlabs' Noise Equivalent Power White Paper.

Dark Resistance

Dark Resistance is the resistance of the detector under no illumination. It is important to note that dark resistance will increase or decrease with temperature. Cooling the device will increase the dark resistance. Provided in chapter 4 of the operating manuals is a Dark Resistance vs. Temperature characteristic graph for each particular detector.

Detectivity (D) and Specific Detectivity (D*)

Detectivity (D) is another criteria used to evaluate the performance of the photodetector. Detectivity is a measure of sensitivity and is the reciprocal of NEP.

$$D = \frac{1}{NEP}$$

Higher values of detectivity indicate higher sensitivity, making the detector more suitable for detecting low light signals. Detectivity varies with the wavelength of the incident photon.

NEP of a detector depends upon the active area of the detector, which in essence will also affect detectivity. This makes it hard to compare the intrinsic properties of two detectors. To remove the dependence, Specific Detectivity (D^*), which is not dependent on detector area, is used to evaluate the performance

of the photodetector. In the equation below, A is the area of the photosensitive region of the detector and Δf is the effective noise bandwidth.

$$D^* = \frac{\sqrt{A \cdot \Delta f}}{NEP}$$

CROSS REFERENCE

The following table lists Thorlabs' selection of photodiodes and photoconductive detectors. Item numbers in the same row contain the same detector element.

Photodetector Cross Reference						
Wavelength	Material	Unmounted Photodiode	Unmounted Photoconductor	Mounted Photodiode	Biased Detector	Amplified Detector
150 - 550 nm	GaP	FGAP71	-	SM05PD7A	DET25K2	PDA25K2
200 - 1100 nm	Si	FDS010	-	SM05PD2A SM05PD2B	DET10A2	PDA10A2
	Si	-	-	SM1PD2A	-	-
320 - 1000 nm	Si	-	-	-	-	PDA8A2
320 - 1100 nm	Si	FD11A	-	SM05PD3A	-	PDF10A2
	Si	-	-	-	DET100A2	PDA100A2
340 - 1100 nm	Si	FDS10X10	-	-	-	-
350 - 1100 nm	Si	FDS100 FDS100-CAL ^a	-	SM05PD1A SM05PD1B	DET36A2	PDA36A2
	Si	FDS1010 FDS1010-CAL ^a	-	SM1PD1A SM1PD1B	-	-
400 - 1000 nm	Si	-	-	-	-	PDA015A(/M) FPD310-FS-VIS FPD310-FC-VIS FPD510-FC-VIS FPD510-FS-VIS FPD610-FC-VIS FPD610-FS-VIS
400 - 1100 nm	Si	FDS015 ^b	-	-	-	-
	Si	FDS025 ^b FDS02 ^c	-	-	DET02AFC(/M) DET025AFC(/M) DET025A(/M) DET025AL(/M)	-
400 - 1700 nm	Si & InGaAs	DSD2	-	-	-	-
500 - 1700 nm	InGaAs	-	-	-	DET10N2	-
750 - 1650 nm	InGaAs	-	-	-	-	PDA8GS
800 - 1700 nm	InGaAs	FGA015	-	-	-	PDA015C(/M)
	InGaAs	FGA21 FGA21-CAL ^a	-	SM05PD5A	DET20C2	PDA20C2 PDA20CS2
	InGaAs	FGA01 ^b FGA01FC ^c	-	-	DET01CFC(/M)	-
	InGaAs	FDGA05 ^b	-	-	-	PDA05CF2
	InGaAs	-	-	-	DET08CFC(/M) DET08C(/M) DET08CL(/M)	PDF10C(/M)
800 - 1800 nm	Ge	FDG03 FDG03-CAL ^a	-	SM05PD6A	DET30B2	PDA30B2
	Ge	FDG50	-	-	DET50B2	PDA50B2
	Ge	FDG05	-	-	-	-
900 - 1700 nm	InGaAs	FGA10	-	SM05PD4A	DET10C2	PDA10CS2
900 - 2600 nm	InGaAs	FD05D	-	-	DET05D2	-
		FD10D	-	-	DET10D2	PDA10D2
950 - 1650 nm	InGaAs	-	-	-	-	FPD310-FC-NIR FPD310-FS-NIR FPD510-FC-NIR FPD510-FS-NIR FPD610-FC-NIR FPD610-FS-NIR
1.0 - 2.9 μ m	PbS	-	FDPS3X3	-	-	-
1.0 - 5.8 μ m	InAsSb	-	-	-	-	PDA10PT(-EC)
1.5 - 4.8 μ m	PbSe	-	FDPSE2X2	-	-	PDA20H(-EC)
2.0 - 5.4 μ m	HgCdTe (MCT)	-	-	-	-	PDA10JT(-EC)

Photodetector Cross Reference

Wavelength	Material	Unmounted Photodiode	Unmounted Photoconductor	Mounted Photodiode	Biased Detector	Amplified Detector
2.0 - 8.0 μm	HgCdTe (MCT)	VML8T0 VML8T4 ^d	-	-	-	PDAVJ8
2.0 - 10.6 μm	HgCdTe (MCT)	VML10T0 VML10T4 ^d	-	-	-	PDAVJ10
2.7 - 5.0 μm	HgCdTe (MCT)	VL5T0	-	-	-	PDAVJ5
2.7 - 5.3 μm	InAsSb	-	-	-	-	PDA07P2

- a. Calibrated Unmounted Photodiode
 b. Unmounted TO-46 Can Photodiode
 c. Unmounted TO-46 Can Photodiode with FC/PC Bulkhead
 d. Photovoltaic Detector with Thermoelectric Cooler

PbS Photoconductor: 1.0 - 2.9 μm

- ▶ Good Performance for 1.0 - 2.9 μm Range
- ▶ For Detection of CW Light We Recommend an Optical Chopper

Item # ^a	Info	Wavelength Range	Active Area	Package Type	Rise Time ^b	Peak Wavelength	Peak Sensitivity ^c	Specific Detectivity ^d	Dark Resistance	Compatible Sockets
FDPS3X3		1.0 - 2.9 μm	9 mm ²	TO-5	200 μs	2.2 μm (Typ.)	2×10^4 V/W (Min) 5.0×10^4 V/W (Typ.)	1×10^{11} cm ² Hz ^{1/2} /W (Typ.)	0.25 - 2.5 MOhm	STO5S STO5P

- a. All measurements performed with a 50 Ohm load unless stated otherwise.
 b. Rise Time is measured from 0 to 63% of final value.
 c. Measured at Peak Wavelength, Chopping Frequency of 600 Hz, and Bias Voltage of 15 V, $R_{\text{DARK}} = R_{\text{LOAD}}$
 d. Measured at Peak Wavelength and Chopping Frequency of 600 Hz

Part Number	Description	Price	Availability
FDPS3X3	PbS Photoconductor, 3 mm x 3 mm Active Area, 200 μs Rise Time, 1.0 - 2.9 μm	\$196.95	Lead Time

PbSe Photoconductor: 1.5 - 4.8 μm

- ▶ Good Performance for 1.5 - 4.8 μm Range
- ▶ For Detection of CW Light We Recommend an Optical Chopper
- ▶ Also Comes as a Packaged, Amplified Detector, the PDA20H

Item # ^a	Info	Wavelength Range	Active Area	Package Type	Rise Time ^b	Peak Wavelength	Peak Sensitivity ^c	Specific Detectivity ^d	Dark Resistance	Compatible Sockets
FDPSE2X2		1.5 - 4.8 μm	4 mm ²	TO-5	10 μs	4 μm (Typ.)	1.5×10^3 V/W (Min) 3.0×10^3 V/W (Typ.)	2.5×10^9 cm ² Hz ^{1/2} /W (Typ.)	0.1 - 3.0 MOhm	STO5S STO5P

- a. All measurements performed with 25 °C element temperature unless stated otherwise.
 b. Rise Time is measured from 0 - 63% of final value.
 c. Measured at Peak Wavelength, Chopping Frequency of 600Hz, and Bias Voltage of 15 V, $R_{\text{DARK}} = R_{\text{LOAD}}$
 d. Measured at Peak Wavelength and a Chopping Frequency of 600 Hz

Part Number	Description	Price	Availability
FDPSE2X2	PbSe Photoconductor, 2 mm x 2 mm Active Area, 10 μs Rise Time, 1.5 - 4.8 μm	\$232.66	Today

Visit the *IR Photoconductive Detectors* page for pricing and availability information:
https://www.thorlabs.com/newgrouppage9.cfm?objectgroup_id=6479

Specs**Responsivity****Pin Diagram****Electrical Specifications ^a**

Wavelength Range	1.0 - 2.9 μm
Peak Wavelength	2.2 μm (Typ.)
Active Area	9 mm ² (3 mm x 3 mm)
Rise Time (0 to 63%) ^b	200 μs
Peak Sensitivity ^c	2 x 10 ⁴ V/W (Min) 5 x 10 ⁴ V/W (Typ.)
Bias Voltage	100V
Dark Resistance	0.25 to 2.5 MOhms
Detectivity (λ_p , 600, 1) ^d	1 x 10 ¹¹ cmHz ^{1/2} /W (Typ.)
Detector	PbS

General

Package	TO-5
Operating Temperature	-30 to 65 °C
Storage Temperature	-55 to 65 °C

a. All measurements performed with a 50 Ohm load unless stated otherwise

b. Rise Time is measured from 0 - 63% of final value

c. Measured at peak wavelength, chopping frequency of 600 Hz, and bias voltage of 15 V, $R_{\text{DARK}} = R_{\text{LOAD}}$

d. Measured at peak wavelength and a chopping frequency of 600 Hz

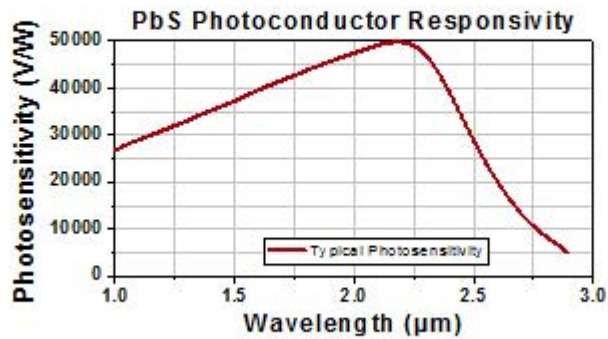
Specs**Responsivity****Pin Diagram**

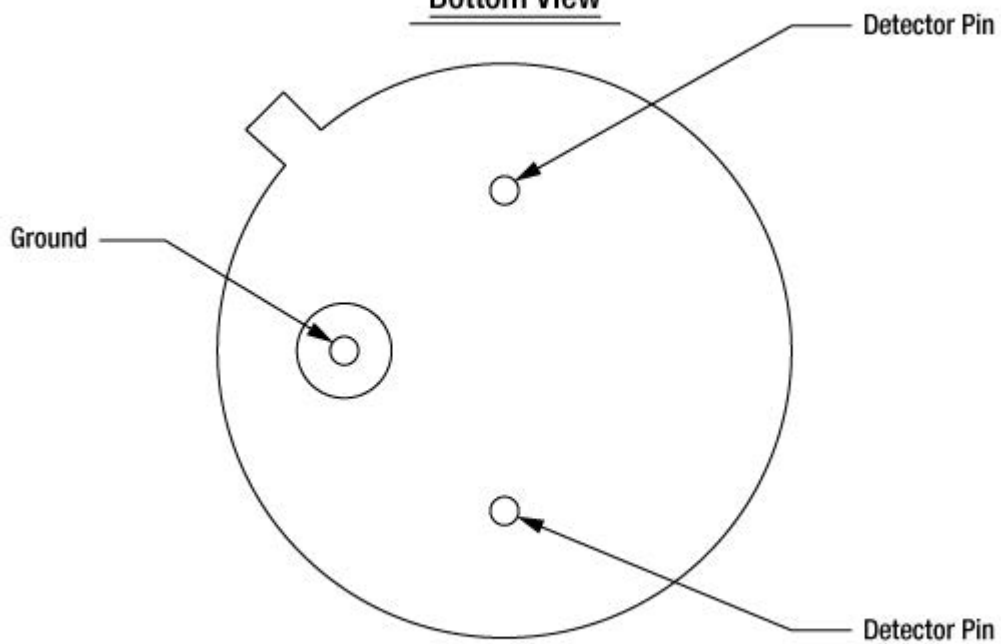
Bottom View

The photoconductor should be connected as a resistor, using the two "detector pins".

