

56 Sparta Avenue • Newton, New Jersey 07860  
 (973) 300-3000 Sales • (973) 300-3600 Fax  
 www.thorlabs.com



## AC508-1000-A - August 18, 2020

Item # AC508-1000-A was discontinued on August 18, 2020. For informational purposes, this is a copy of the website content at that time and is valid only for the stated product.

### UNMOUNTED ACHROMATIC DOUBLETS, AR COATED: 400 - 700 nm

- ▶ Achromatic Performance with AR Coating for 400 - 700 nm
- ▶ Multi-Element Design Minimizes Spot Size
- ▶ Custom Achromatic Optic Available



AC508-180-A  
f = 180 mm, Ø2"



AC254-080-A  
f = 80 mm, Ø1"



AC127-050-A  
f = 50 mm, Ø1/2"



AC080-016-A  
f = 16 mm, Ø8 mm



AC060-010-A  
f = 10 mm, Ø6 mm

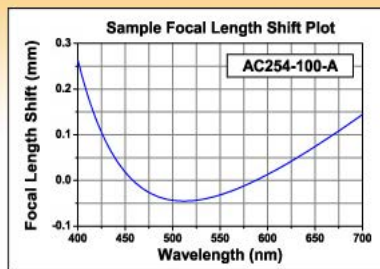

[Hide Overview](#)

#### OVERVIEW

##### Features

- AR Coated for the 400 - 700 nm Range
- Positive Doublet Sizes from Ø5 mm to Ø2"
- Negative Doublet Sizes from Ø1/2" to Ø2"
- 7.5 to 1000 mm Focal Lengths for Positive Doublets
- -20 to -100 mm Focal Lengths for Negative Doublets
- Custom Achromatic Optics Available

##### Zemax Files

Click on the red Document icon next to the item numbers below to access the Zemax file download. Our entire Zemax Catalog is also available.



Thorlabs' cemented Achromatic Doublets are optimized to provide excellent performance in the visible region. Our design for the achromatic doublets uses the helium "d" line (587.6 nm, yellow) and the hydrogen "F" (486.1 nm, blue/green) and "C" (656.3 nm, red) lines since these wavelengths reasonably represent the visible spectrum and are used to define the Abbe Number,  $V_d$ , of a material.

To see how the performance of achromatic doublets compares to single lenses, refer to the *Application* tab above. In addition, the *Performance* tab gives examples of how the performance of achromatic doublets can be analyzed by downloading the Zemax® files found by clicking the document icon next to the appropriate part number below.

For best performance, the side of the lens with the largest radius of curvature (flattest side) should face away from the collimated beam. Doublets Ø1/2" and larger are engraved with the item # on their edge, oriented so that the text is right-side up when the flattest side of the lens is the bottom surface. Please see the diagram under the reference drawing link below for additional details.

Recommended lens mounts are given in the text under each table below. Alternatively, you can choose an appropriate mount from our entire selection of fixed diameter lens mounts, self-centering adjustable lens mounts, and adjustable lens mounts. When choosing a lens mount, make sure the mount

##### General Specifications

Design Wavelengths	486.1 nm, 587.6 nm, and 656.3 nm	
AR Coating Range	400 - 700 nm	
Reflectance Over AR Coating Range (0° AOI)	$R_{avg} < 0.5\%$	
Diameters Available	Ø5 mm, Ø6 mm, Ø6.35 mm, Ø8 mm, Ø1/2", Ø1", Ø30 mm, and Ø2"	
Diameter Tolerance	+0.0 / -0.1 mm <sup>a</sup>	
Focal Length Tolerance	±1%	
Surface Quality	40-20 Scratch-Dig	
Spherical Surface Power <sup>b,c</sup>	3λ/2	
Spherical Surface Irregularity (Peak to Valley) <sup>c</sup>	λ/4	
Centration	<3 arcmin	
Clear Aperture	>90% of Diameter	
Damage Threshold <sup>d</sup>	Pulsed	0.5 J/cm <sup>2</sup> (532 nm, 10 ns Pulse, 10 Hz, Ø0.566 mm)
	CW <sup>e</sup>	1000 W/cm (532 nm, Ø1.000 mm)
Operating Temperature	-40 °C to 85 °C	

- Except AC254-080-A, AC254-125-A, and AC508-180-A, which have a diameter tolerance of -0.00 mm / -0.1 mm.
- Much like surface flatness for flat optics, spherical surface power is a measure of the deviation between the surface of the curved optic and a calibrated reference gauge. This specification is also commonly referred to as surface fit.
- At 633 nm.
- The damage threshold of cemented achromatic doublets is limited by the cement. For applications that require higher damage thresholds, please consider our air-spaced doublets.
- The power density of your beam should be calculated in terms of W/cm. For an explanation of why the linear power density provides the best metric for long pulse and CW sources, please see the *Damage Thresholds* tab.

##### Achromatic Doublet Selection Guide

Unmounted Lenses	Mounted Lenses
Visible (400 - 700 nm)	Visible (400 - 700 nm)
Extended Visible (400 - 1100 nm)	Extended Visible (400 - 1100 nm)
Near IR (650 - 1050 nm)	Near IR (650 - 1050 nm)

can accommodate the diameter and edge thickness specifications of the lens. The achromatic doublets featured on this page are also available mounted. For applications in wavelength regimes less than 410 nm, Thorlabs' air-gap UV doublets provide excellent performance down to 240 nm.

In the specification tables below, a positive radius of curvature indicates that the surface is opening to the right when the lens is oriented as shown in the reference drawing; a negative radius of curvature indicates that the surface is opening to the left. Both the positive and negative lenses have an infinite conjugate ratio (i.e., if a diverging light source is placed one focal length away from the flatter side of the lens, the light rays emerging from the curved side will be collimated).

**Custom Achromatic Lenses**

Thorlabs' optics business unit has a wide breadth of manufacturing capabilities that allow us to offer a variety of custom achromatic optics for both OEM sales and low quantity one-off orders. Achromatic optics with customer-defined sizes, focal lengths, substrate materials, cement materials, and coatings are all available as customs. In addition, we can offer optics that exceed the specifications of our stock catalog offerings. To receive more information or inquire about a custom order, please contact Tech Support.

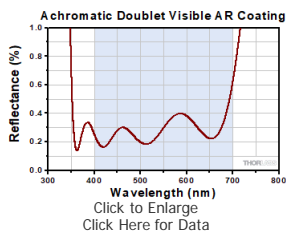

[Hide Performance](#)

**PERFORMANCE**

Detailed information regarding each achromatic doublet can be found in the Zemax® files included with the support documents for each doublet. Below are some examples of how the performance of these lenses can be examined using the Zemax® files.

**Focal Shift vs. Wavelength**

Thorlabs' achromatic doublets are optimized to provide a nearly constant focal length across a broad bandwidth. This is accomplished by utilizing a multi-element design to minimize the chromatic aberration of the lens. Dispersion in the first (positive) element of the doublet is corrected by the second (negative) element, resulting in better broadband performance than spherical singlets or aspheric lenses. The graph below shows the paraxial focal shift as a function of wavelength for the AC254-400-A, which is a 400 mm focal length, Ø25.4 mm visible achromatic doublet.

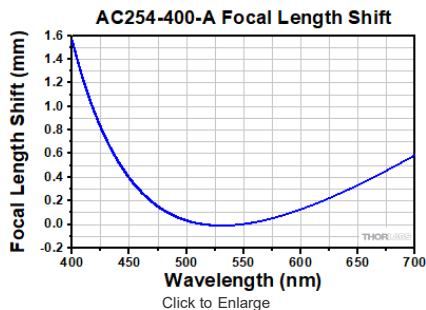

Figure 1

**Wavefront Error and Spot Size**

Thorlabs' spherical doublet lenses have been corrected for various aberrations, including spherical aberration, chromatic aberration, and coma. One way of displaying the theoretical level of correction is through plots of wavefront error and ray traces to determine spot size. For example, in Figure 2, a plot of wavefront at the image plane reveals information regarding aberration correction by using the AC254-125-C. In this example, the wavefront error is theoretically on the order of 3/100 of a wave. This indicates that the optical path length difference (OPD) is extremely small for arrays going through the center of the lens and at nearly full aperture.

A ray trace for spot size at the image plane of the AC254-250-C is shown below in Figure 3. In this near IR achromatic doublet, the design wavelengths (706.5 nm, 855 nm and 1015 nm) have each been traced through the lens and are represented by different colors. The circle surrounding the distribution of ray intercepts represents the diameter of the Airy disk. If the spot is within the Airy disk, the lens is typically considered to be diffraction limited. Since the spot size is drawn using geometric ray tracing, spots much smaller than the Airy disk are not achievable due to diffraction.



Click to Enlarge  
Figure 2

**Understanding Modulation Transfer Function, MTF**

MTF image quality is an important characteristic of lenses. A common way to measure this is by using contrast. A plot of the modulation transfer function is used as both a theoretical and experimental description of image quality. The MTF of a lens describes its ability to transfer contrast from an object to an image at various resolution levels. Typically, a resolution target made up of black and white lines at various spacings is imaged and contrast can be measured. Contrast at 100% would consist of perfectly black and white lines. As the contrast diminishes, the distinction between lines begins to blur. A plot of MTF shows the percentage of contrast as the spacing between these lines decreases. The spacing between the lines at the object is usually represented as spatial frequency given in cycles/mm.



Click to Enlarge  
Figure 3

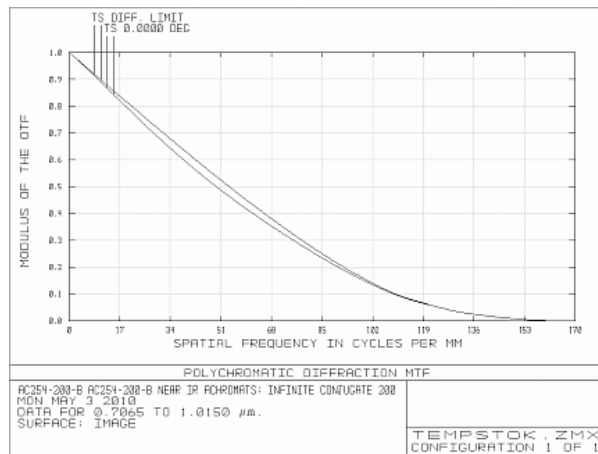

Click to Enlarge  
Figure 4

The chart shows the theoretical MTF for our Ø25.4 mm, f=200 mm near IR achromatic doublet. The contrast is around 83% at a spatial frequency of about 20 cycles/mm. This represents 83% contrast at 0.05 mm spacings between lines. Theoretical MTF shows how well a design can perform if the optic was built exactly to the design dimensions. In reality, most optics fall short of the theoretical due to manufacturing tolerances.

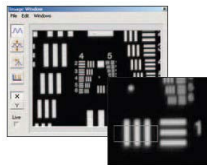

The screen captures to the right and left are actual measurements taken using a USAF 1951 resolution chart as the object.

For the target selected, the contrast measured 82.3%.

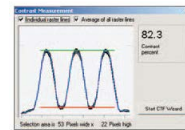

[Hide Application](#)

## APPLICATION

**Achromatic Doublet Lenses** have far superior optical performance to Singlet Lenses. In addition, they offer better broadband and off-axis performance than Aspheric Lenses. Whether your application has demanding imaging requirements or laser beam manipulation needs, these doublets should be considered.

### Achieve a Tighter Focus

The figures below show a comparison of a plano-convex singlet focusing a 633 nm laser beam and an achromatic doublet focusing the same laser beam. The spot (circle of least confusion) from the doublet is 4.2 times smaller than the singlet spot size.

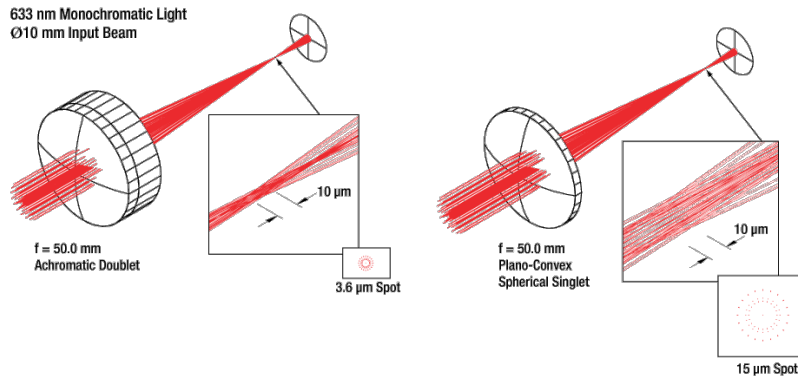

### Superior Off Axis Performance

Achromatic doublet lenses have a much reduced sensitivity to centration on the beam axis when compared to spherical singlets and aspheric lenses.

The figures below show two 50.0 mm focal length lenses, one plano-convex and the other an achromatic doublet. Both are Ø25.4 mm lenses with a Ø3 mm beam through the optical axis and one offset by 8.0 mm. Lateral and transverse aberrations are greatly reduced by the achromatic doublet.

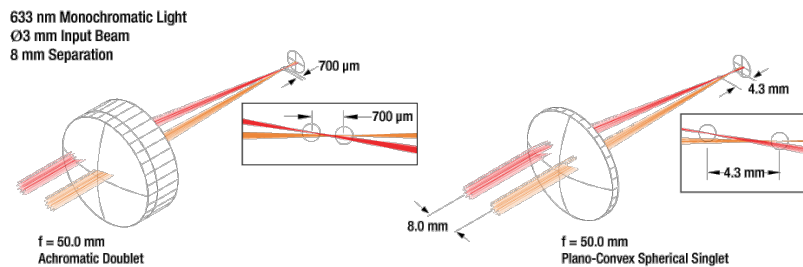

### Nearly Constant Focal Length Across a Wide Range of Wavelengths

When using a white light source with a singlet lens, the focal point and circle of least confusion are blurred by chromatic aberration. Chromatic aberration is due to the variation of refractive index with respect to wavelength. In an achromatic doublet this effect is somewhat compensated for by using glasses of two different refractive indexes to cancel these aberrations.

The figures below show the effect on focal length for a number of different wavelengths of light through an achromatic doublet and a plano-convex singlet. The figures also shows how the circle of least confusion for white light is reduced by using an achromatic doublet.

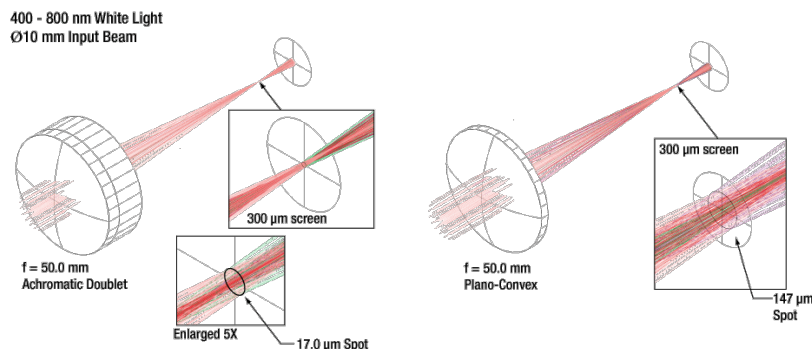

[Hide Damage Thresholds](#)

## DAMAGE THRESHOLDS

### Damage Threshold Data for Thorlabs' A-Coated Achromatic Doublets

The specifications to the right are measured data for Thorlabs' A-coated achromatic doublets. The damage threshold of cemented achromatic doublets is limited by the cement. For applications that require higher damage thresholds, please consider our air-spaced doublets. These specifications are valid for all A-coated, cemented achromatic doublets, regardless of the size or focal length of the lens.

Damage Threshold Specifications	
A-Coated, Cemented Achromatic Doublets	
Pulsed	0.5 J/cm <sup>2</sup> (532 nm, 10 ns, 10 Hz, Ø0.566 mm)
CW <sup>a</sup>	1000 W/cm (532 nm, Ø1.000 mm)

a. The power density of your beam should be calculated in terms of W/cm. For an explanation of why the linear power density provides the best metric for long pulse and CW sources, please see the "Continuous Wave and Long-Pulse Lasers" section below.

### Laser Induced Damage Threshold Tutorial

The following is a general overview of how laser induced damage thresholds are measured and how the values may be utilized in determining the appropriateness of an optic for a given application. When choosing optics, it is important to understand the Laser Induced Damage Threshold (LIDT) of the optics being used. The LIDT for an optic greatly depends on the type of laser you are using. Continuous wave (CW) lasers typically cause damage from thermal effects (absorption either in the coating or in the substrate). Pulsed lasers, on the other hand, often strip electrons from the lattice structure of an optic before causing thermal damage. Note that the guideline presented here assumes room temperature operation and optics in new condition (i.e., within scratch-dig spec, surface free of contamination, etc.). Because dust or other particles on the surface of an optic can cause damage at lower thresholds, we recommend keeping surfaces clean and free of debris. For more information on cleaning optics, please see our *Optics Cleaning* tutorial.

### Testing Method

Thorlabs' LIDT testing is done in compliance with ISO/DIS 11254 and ISO 21254 specifications.

First, a low-power/energy beam is directed to the optic under test. The optic is exposed in 10 locations to this laser beam for 30 seconds (CW) or for a number of pulses (pulse repetition frequency specified). After exposure, the optic is examined by a microscope (~100X magnification) for any visible damage. The number of locations that are damaged at a particular power/energy level is recorded. Next, the power/energy is either increased or decreased and the optic is exposed at 10 new locations. This process is repeated until damage is observed. The damage threshold is then assigned to be the highest power/energy that the optic can withstand without causing damage. A histogram such as that below represents the testing of one BB1-E02 mirror.



The photograph above is a protected aluminum-coated mirror after LIDT testing. In this particular test, it handled 0.43 J/cm<sup>2</sup> (1064 nm, 10 ns pulse, 10 Hz, Ø1.000 mm) before damage.

According to the test, the damage threshold of the mirror was 2.00 J/cm<sup>2</sup> (532 nm, 10 ns pulse, 10 Hz, Ø0.803 mm). Please keep in mind that these tests are performed on clean optics, as dirt and contamination can significantly lower the damage threshold of a component. While the test results are only representative of one coating run, Thorlabs specifies damage threshold values that account for coating variances.

### Continuous Wave and Long-Pulse Lasers

When an optic is damaged by a continuous wave (CW) laser, it is usually due to the melting of the surface as a result of absorbing the laser's energy or damage to the optical coating (antireflection) [1]. Pulsed lasers with pulse lengths longer than 1 μs can be treated as CW lasers for LIDT discussions.

When pulse lengths are between 1 ns and 1 μs, laser-induced damage can occur either because of absorption or a dielectric breakdown (therefore, a user must check both CW and pulsed LIDT). Absorption is either due to an intrinsic property of the optic or due to surface irregularities; thus LIDT values are only valid for optics meeting or exceeding the surface quality specifications given by a manufacturer. While many optics can handle high power CW lasers, cemented (e.g., achromatic doublets) or highly absorptive (e.g., ND filters) optics tend to have lower CW damage thresholds. These lower thresholds are due to absorption or scattering in the cement or metal coating.

Pulsed lasers with high pulse repetition frequencies (PRF) may behave similarly to CW beams. Unfortunately, this is highly dependent on factors such as absorption and thermal diffusivity, so there is no reliable method for determining when a high PRF laser will damage an optic due to thermal effects. For beams with a high PRF both the average and peak powers must be compared to the equivalent CW power. Additionally, for highly transparent materials, there is little to no drop in the LIDT with increasing PRF.

In order to use the specified CW damage threshold of an optic, it is necessary to know the following:

1. Wavelength of your laser
2. Beam diameter of your beam (1/e<sup>2</sup>)
3. Approximate intensity profile of your beam (e.g., Gaussian)
4. Linear power density of your beam (total power divided by 1/e<sup>2</sup> beam diameter)

Thorlabs expresses LIDT for CW lasers as a linear power density measured in W/cm. In this regime, the LIDT given as a linear power density can be applied to any beam diameter; one does not need to compute an adjusted LIDT to adjust for changes in spot size, as demonstrated by the graph to the right. Average linear power density can be calculated using the equation below.

$$\text{Linear Power Density} = \frac{\text{Power}}{\text{Beam Diameter}}$$

The calculation above assumes a uniform beam intensity profile. You must now consider hotspots in the beam or other non-uniform intensity profiles and roughly calculate a maximum power density. For reference, a Gaussian beam typically has a maximum power density that is twice that of the uniform beam (see lower right).

Now compare the maximum power density to that which is specified as the LIDT for the optic. If the optic was tested at a wavelength other than your operating wavelength, the damage threshold must be scaled appropriately. A good rule of thumb is that the damage threshold has a linear relationship with wavelength such that as you move to shorter wavelengths, the damage threshold decreases (i.e., a LIDT of 10 W/cm at 1310 nm scales to 5 W/cm at 655 nm):

$$\text{Adjusted LIDT} = \text{LIDT Power} \left( \frac{\text{Your Wavelength}}{\text{LIDT Wavelength}} \right)$$

While this rule of thumb provides a general trend, it is not a quantitative analysis of LIDT vs wavelength. In CW applications, for instance, damage scales more strongly with absorption in the coating and substrate, which does not necessarily scale well with wavelength. While the above procedure provides a good rule of thumb for LIDT values, please contact Tech Support if your wavelength is different from the specified LIDT wavelength. If your power density is less than the adjusted LIDT of the optic, then the optic should work for your application.

Please note that we have a buffer built in between the specified damage thresholds online and the tests which we have done, which accommodates variation between batches. Upon request, we can provide individual test information and a testing certificate. The damage analysis will be carried out on a similar optic (customer's optic will not be damaged). Testing may result in additional costs or lead times. Contact Tech Support for more information.

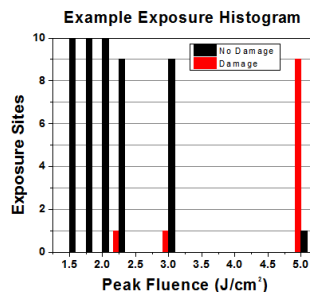

Example Test Data			
Fluence	# of Tested Locations	Locations with Damage	Locations Without Damage
1.50 J/cm <sup>2</sup>	10	0	10
1.75 J/cm <sup>2</sup>	10	0	10
2.00 J/cm <sup>2</sup>	10	0	10
2.25 J/cm <sup>2</sup>	10	1	9
3.00 J/cm <sup>2</sup>	10	1	9
5.00 J/cm <sup>2</sup>	10	9	1

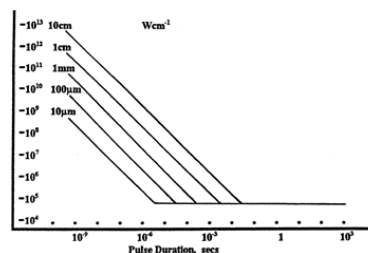

LIDT in linear power density vs. pulse length and spot size. For long pulses to CW, linear power density becomes a constant with spot size. This graph was obtained from [1].

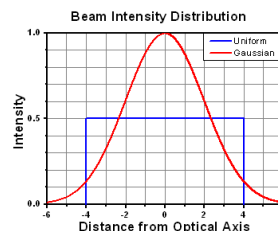

## Pulsed Lasers

As previously stated, pulsed lasers typically induce a different type of damage to the optic than CW lasers. Pulsed lasers often do not heat the optic enough to damage it; instead, pulsed lasers produce strong electric fields capable of inducing dielectric breakdown in the material. Unfortunately, it can be very difficult to compare the LIDT specification of an optic to your laser. There are multiple regimes in which a pulsed laser can damage an optic and this is based on the laser's pulse length. The highlighted columns in the table below outline the relevant pulse lengths for our specified LIDT values.

Pulses shorter than  $10^{-9}$  s cannot be compared to our specified LIDT values with much reliability. In this ultra-short-pulse regime various mechanics, such as multiphoton-avalanche ionization, take over as the predominate damage mechanism [2]. In contrast, pulses between  $10^{-7}$  s and  $10^{-4}$  s may cause damage to an optic either because of dielectric breakdown or thermal effects. This means that both CW and pulsed damage thresholds must be compared to the laser beam to determine whether the optic is suitable for your application.

Pulse Duration	$t < 10^{-9}$ s	$10^{-9} < t < 10^{-7}$ s	$10^{-7} < t < 10^{-4}$ s	$t > 10^{-4}$ s
Damage Mechanism	Avalanche Ionization	Dielectric Breakdown	Dielectric Breakdown or Thermal	Thermal
Relevant Damage Specification	No Comparison (See Above)	Pulsed	Pulsed and CW	CW

When comparing an LIDT specified for a pulsed laser to your laser, it is essential to know the following:

1. Wavelength of your laser
2. Energy density of your beam (total energy divided by  $1/e^2$  area)
3. Pulse length of your laser
4. Pulse repetition frequency (prf) of your laser
5. Beam diameter of your laser ( $1/e^2$ )
6. Approximate intensity profile of your beam (e.g., Gaussian)

The energy density of your beam should be calculated in terms of  $J/cm^2$ . The graph to the right shows why expressing the LIDT as an energy density provides the best metric for short pulse sources. In this regime, the LIDT given as an energy density can be applied to any beam diameter; one does not need to compute an adjusted LIDT to adjust for changes in spot size. This calculation assumes a uniform beam intensity profile. You must now adjust this energy density to account for hotspots or other nonuniform intensity profiles and roughly calculate a maximum energy density. For reference a Gaussian beam typically has a maximum energy density that is twice that of the  $1/e^2$  beam.

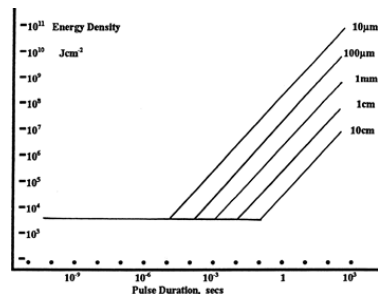

LIDT in energy density vs. pulse length and spot size. For short pulses, energy density becomes a constant with spot size. This graph was obtained from [1].

Now compare the maximum energy density to that which is specified as the LIDT for the optic. If the optic was tested at a wavelength other than your operating wavelength, the damage threshold must be scaled appropriately [3]. A good rule of thumb is that the damage threshold has an inverse square root relationship with wavelength such that as you move to shorter wavelengths, the damage threshold decreases (i.e., a LIDT of  $1 J/cm^2$  at  $1064$  nm scales to  $0.7 J/cm^2$  at  $532$  nm):

$$\text{Adjusted LIDT} = \text{LIDT Energy} \sqrt{\frac{\text{Your Wavelength}}{\text{LIDT Wavelength}}}$$

You now have a wavelength-adjusted energy density, which you will use in the following step.

Beam diameter is also important to know when comparing damage thresholds. While the LIDT, when expressed in units of  $J/cm^2$ , scales independently of spot size; large beam sizes are more likely to illuminate a larger number of defects which can lead to greater variances in the LIDT [4]. For data presented here, a  $<1$  mm beam size was used to measure the LIDT. For beams sizes greater than  $5$  mm, the LIDT ( $J/cm^2$ ) will not scale independently of beam diameter due to the larger size beam exposing more defects.

The pulse length must now be compensated for. The longer the pulse duration, the more energy the optic can handle. For pulse widths between  $1 - 100$  ns, an approximation is as follows:

$$\text{Adjusted LIDT} = \text{LIDT Energy} \sqrt{\frac{\text{Your Pulse Length}}{\text{LIDT Pulse Length}}}$$

Use this formula to calculate the Adjusted LIDT for an optic based on your pulse length. If your maximum energy density is less than this adjusted LIDT maximum energy density, then the optic should be suitable for your application. Keep in mind that this calculation is only used for pulses between  $10^{-9}$  s and  $10^{-7}$  s. For pulses between  $10^{-7}$  s and  $10^{-4}$  s, the CW LIDT must also be checked before deeming the optic appropriate for your application.

Please note that we have a buffer built in between the specified damage thresholds online and the tests which we have done, which accommodates variation between batches. Upon request, we can provide individual test information and a testing certificate. Contact Tech Support for more information.

[1] R. M. Wood, Optics and Laser Tech. **29**, 517 (1998).

[2] Roger M. Wood, *Laser-Induced Damage of Optical Materials* (Institute of Physics Publishing, Philadelphia, PA, 2003).

[3] C. W. Carr *et al.*, Phys. Rev. Lett. **91**, 127402 (2003).

[4] N. Bloembergen, Appl. Opt. **12**, 661 (1973).

[Hide LIDT Calculations](#)

## LIDT CALCULATIONS

In order to illustrate the process of determining whether a given laser system will damage an optic, a number of example calculations of laser induced damage threshold are given below. For assistance with performing similar calculations, we provide a spreadsheet calculator that can be downloaded by clicking the button to the right. To use

[LIDT Calculator](#)

the calculator, enter the specified LIDT value of the optic under consideration and the relevant parameters of your laser system in the green boxes. The spreadsheet will then calculate a linear power density for CW and pulsed systems, as well as an energy density value for pulsed systems. These values are used to calculate adjusted, scaled LIDT values for the optics based on accepted scaling laws. This calculator assumes a Gaussian beam profile, so a correction factor must be introduced for other beam shapes (uniform, etc.). The LIDT scaling laws are determined from empirical relationships; their accuracy is not guaranteed. Remember that absorption by optics or coatings can significantly reduce LIDT in some spectral regions. These LIDT values are not valid for ultrashort pulses less than one nanosecond in duration.

#### CW Laser Example

Suppose that a CW laser system at 1319 nm produces a 0.5 W Gaussian beam that has a  $1/e^2$  diameter of 10 mm. A naive calculation of the average linear power density of this beam would yield a value of 0.5 W/cm, given by the total power divided by the beam diameter:

$$\text{Linear Power Density} = \frac{\text{Power}}{\text{Beam Diameter}}$$

However, the maximum power density of a Gaussian beam is about twice the maximum power density of a uniform beam, as shown in the graph to the right. Therefore, a more accurate determination of the maximum linear power density of the system is 1 W/cm.

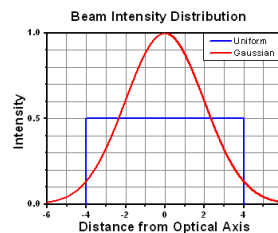

A Gaussian beam profile has about twice the maximum intensity of a uniform beam profile.

An AC127-030-C achromatic doublet lens has a specified CW LIDT of 350 W/cm, as tested at 1550 nm. CW damage threshold values typically scale directly with the wavelength of the laser source, so this yields an adjusted LIDT value:

$$\text{Adjusted LIDT} = \text{LIDT Power} \left( \frac{\text{Your Wavelength}}{\text{LIDT Wavelength}} \right)$$

The adjusted LIDT value of 350 W/cm  $\times$  (1319 nm / 1550 nm) = 298 W/cm is significantly higher than the calculated maximum linear power density of the laser system, so it would be safe to use this doublet lens for this application.

#### Pulsed Nanosecond Laser Example: Scaling for Different Pulse Durations

Suppose that a pulsed Nd:YAG laser system is frequency tripled to produce a 10 Hz output, consisting of 2 ns output pulses at 355 nm, each with 1 J of energy, in a Gaussian beam with a 1.9 cm beam diameter ( $1/e^2$ ). The average energy density of each pulse is found by dividing the pulse energy by the beam area:

$$\text{Energy Density} = \frac{\text{Pulse Energy}}{\text{Beam Area}}$$

As described above, the maximum energy density of a Gaussian beam is about twice the average energy density. So, the maximum energy density of this beam is  $\sim 0.7 \text{ J/cm}^2$ .

The energy density of the beam can be compared to the LIDT values of 1 J/cm<sup>2</sup> and 3.5 J/cm<sup>2</sup> for a BB1-E01 broadband dielectric mirror and an NB1-K08 Nd:YAG laser line mirror, respectively. Both of these LIDT values, while measured at 355 nm, were determined with a 10 ns pulsed laser at 10 Hz. Therefore, an adjustment must be applied for the shorter pulse duration of the system under consideration. As described on the previous tab, LIDT values in the nanosecond pulse regime scale with the square root of the laser pulse duration:

$$\text{Adjusted LIDT} = \text{LIDT Energy} \sqrt{\frac{\text{Your Pulse Length}}{\text{LIDT Pulse Length}}}$$

This adjustment factor results in LIDT values of 0.45 J/cm<sup>2</sup> for the BB1-E01 broadband mirror and 1.6 J/cm<sup>2</sup> for the Nd:YAG laser line mirror, which are to be compared with the 0.7 J/cm<sup>2</sup> maximum energy density of the beam. While the broadband mirror would likely be damaged by the laser, the more specialized laser line mirror is appropriate for use with this system.

#### Pulsed Nanosecond Laser Example: Scaling for Different Wavelengths

Suppose that a pulsed laser system emits 10 ns pulses at 2.5 Hz, each with 100 mJ of energy at 1064 nm in a 16 mm diameter beam ( $1/e^2$ ) that must be attenuated with a neutral density filter. For a Gaussian output, these specifications result in a maximum energy density of 0.1 J/cm<sup>2</sup>. The damage threshold of an NDUV10A Ø25 mm, OD 1.0, reflective neutral density filter is 0.05 J/cm<sup>2</sup> for 10 ns pulses at 355 nm, while the damage threshold of the similar NE10A absorptive filter is 10 J/cm<sup>2</sup> for 10 ns pulses at 532 nm. As described on the previous tab, the LIDT value of an optic scales with the square root of the wavelength in the nanosecond pulse regime:

$$\text{Adjusted LIDT} = \text{LIDT Energy} \sqrt{\frac{\text{Your Wavelength}}{\text{LIDT Wavelength}}}$$

This scaling gives adjusted LIDT values of 0.08 J/cm<sup>2</sup> for the reflective filter and 14 J/cm<sup>2</sup> for the absorptive filter. In this case, the absorptive filter is the best choice in order to avoid optical damage.

#### Pulsed Microsecond Laser Example

Consider a laser system that produces 1  $\mu\text{s}$  pulses, each containing 150  $\mu\text{J}$  of energy at a repetition rate of 50 kHz, resulting in a relatively high duty cycle of 5%. This system falls somewhere between the regimes of CW and pulsed laser induced damage, and could potentially damage an optic by mechanisms associated with either regime. As a result, both CW and pulsed LIDT values must be compared to the properties of the laser system to ensure safe operation.

If this relatively long-pulse laser emits a Gaussian 12.7 mm diameter beam ( $1/e^2$ ) at 980 nm, then the resulting output has a linear power density of 5.9 W/cm and an energy density of  $1.2 \times 10^{-4} \text{ J/cm}^2$  per pulse. This can be compared to the LIDT values for a WQP10E-980 polymer zero-order quarter-wave plate, which are 5 W/cm for CW radiation at 810 nm and 5 J/cm<sup>2</sup> for a 10 ns pulse at 810 nm. As before, the CW LIDT of the optic scales linearly with the laser wavelength, resulting in an adjusted CW value of 6 W/cm at 980 nm. On the other hand, the pulsed LIDT scales with the square root of the laser wavelength

and the square root of the pulse duration, resulting in an adjusted value of  $55 \text{ J/cm}^2$  for a  $1 \mu\text{s}$  pulse at  $980 \text{ nm}$ . The pulsed LIDT of the optic is significantly greater than the energy density of the laser pulse, so individual pulses will not damage the wave plate. However, the large average linear power density of the laser system may cause thermal damage to the optic, much like a high-power CW beam.

[Hide Ø5 mm Unmounted Positive Achromatic Doublets, AR Coated: 400 - 700 nm](#)

**Ø5 mm Unmounted Positive Achromatic Doublets, AR Coated: 400 - 700 nm**

Item #	Diameter (mm)	$f^a$ (mm)	$f_b^a$ (mm)	Graphs <sup>b</sup>	$R_1^a$ (mm)	$R_2^a$ (mm)	$R_3^a$ (mm)	$t_{c1}$ (mm)	$t_{c2}$ (mm)	$t_e^c$ (mm)	Materials	Reference Drawing
AC050-008-A <sup>d,e</sup>	5.0	7.5	5.2		5.3	-3.9	-17.1	2.8	1.7	3.7	N-BAF10/N-SF6HT	
AC050-010-A <sup>d,e</sup>	5.0	10.0	7.9		6.6	-4.3	-15.4	2.5	1.9	3.7	N-BAK4/SF5	
AC050-015-A <sup>e,f</sup>	5.0	15.0	13.6		12.5	-5.3	-12.1	2.7	2.1	4.3	N-BK7/SF2	

- a. Positive values are measured from the right side of the lens as shown in the reference drawing. Negative values are measured from the left side of the lens.  
 b. Click on for plots and downloadable data of the focal length shift and transmission for the lens.  
 c. Edge thicknesses given here are nominal and may vary from optic to optic.  
 d. Suggested Fixed Lens Mount: MLH5(/M)  
 e. Suggested Fixed Lens Mount: LMR05(/M) with LMRA5 Adapter  
 f. Suggested Fixed Lens Mount: MLH05(/M) with LMRA5 Adapter

Part Number	Description	Price	Availability
AC050-008-A	$f = 7.5 \text{ mm}$ , Ø5 mm Achromatic Doublet, ARC: 400 - 700 nm	\$48.43	Today
AC050-010-A	$f = 10 \text{ mm}$ , Ø5 mm Achromatic Doublet, ARC: 400 - 700 nm	\$47.88	Today
AC050-015-A	$f = 15 \text{ mm}$ , Ø5 mm Achromatic Doublet, ARC: 400 - 700 nm	\$47.88	Today

[Hide Ø6 mm Unmounted Positive Achromatic Doublets, AR Coated: 400 - 700 nm](#)

**Ø6 mm Unmounted Positive Achromatic Doublets, AR Coated: 400 - 700 nm**

Item #	Diameter (mm)	$f^a$ (mm)	$f_b^a$ (mm)	Graphs <sup>b</sup>	$R_1^a$ (mm)	$R_2^a$ (mm)	$R_3^a$ (mm)	$t_{c1}$ (mm)	$t_{c2}$ (mm)	$t_e^c$ (mm)	Materials	Reference Drawing
AC060-010-A	6.0	10.0	7.9		6.2	-4.6	-19.6	2.5	1.5	3.0	N-BAK4/SF5	

- a. Positive values are measured from the right side of the lens as shown in the reference drawing. Negative values are measured from the left side of the lens.  
 b. Click on for plots and downloadable data of the focal length shift and transmission for the lens.  
 c. Edge thicknesses given here are nominal and may vary from optic to optic.

Suggested Fixed Lens Mounts: MLH6(/M) or LMR6(/M)

Part Number	Description	Price	Availability
AC060-010-A	$f = 10 \text{ mm}$ , Ø6 mm Achromatic Doublet, ARC: 400 - 700 nm	\$48.70	Today

[Hide Ø6.35 mm Unmounted Positive Achromatic Doublets, AR Coated: 400 - 700 nm](#)

**Ø6.35 mm Unmounted Positive Achromatic Doublets, AR Coated: 400 - 700 nm**

Item #	Diameter (mm)	$f^a$ (mm)	$f_b^a$ (mm)	Graphs <sup>b</sup>	$R_1^a$ (mm)	$R_2^a$ (mm)	$R_3^a$ (mm)	$t_{c1}$ (mm)	$t_{c2}$ (mm)	$t_e^c$ (mm)	Materials	Reference Drawing
AC064-013-A	6.35	12.7	10.3		7.1	-5.9	-40.4	2.5	1.5	3.1	N-BAK4/SF5	
AC064-015-A	6.35	15.0	13.0		8.8	-6.6	-21.7	2.5	1.5	3.2	N-BK7/SF2	

- a. Positive values are measured from the right side of the lens as shown in the reference drawing. Negative values are measured from the left side of the lens.  
 b. Click on for plots and downloadable data of the focal length shift and transmission for the lens.  
 c. Edge thicknesses given here are nominal and may vary from optic to optic.

Suggested Fixed Lens Mounts: MLH05(/M) or LMR05(/M) with LMRA6.35 Adapter

Part Number	Description	Price	Availability
AC064-013-A	$f = 12.7 \text{ mm}$ , Ø6.35 mm Achromatic Doublet, ARC: 400 - 700 nm	\$48.43	Today
AC064-015-A	$f = 15 \text{ mm}$ , Ø6.35 mm Achromatic Doublet, ARC: 400 - 700 nm	\$48.43	Today

[Hide Ø8.0 mm Unmounted Positive Achromatic Doublets, AR Coated: 400 - 700 nm](#)

**Ø8.0 mm Unmounted Positive Achromatic Doublets, AR Coated: 400 - 700 nm**

Item #	Diameter (mm)	$f^a$ (mm)	$f_b^a$ (mm)	Graphs <sup>b</sup>	$R_1^a$ (mm)	$R_2^a$ (mm)	$R_3^a$ (mm)	$t_{c1}$ (mm)	$t_{c2}$ (mm)	$t_e^c$ (mm)	Materials	Reference Drawing
AC080-010-A <sup>d</sup>	8.0	10.0	6.7		7.1	-5.3	-22.7	4.5	2.0	4.9	N-BAF10/N-SF6HT	
AC080-016-A <sup>e</sup>	8.0	16.0	13.9		11.0	-9.2	-46.8	2.5	1.5	3.1	N-BAF10/N-SF6HT	



AC080-020-A <sup>e</sup>	8.0	20.0	17.8		11.1	-9.2	-34.8	2.5	1.5	3.0	N-BK7/SF2
AC080-030-A <sup>e</sup>	8.0	30.0	27.8		16.0	-13.5	-59.4	2.5	1.5	3.4	N-BK7/N-SF2

- a. Positive values are measured from the right side of the lens as shown in the reference drawing. Negative values are measured from the left side of the lens.
- b. Click on for plots and downloadable data of the focal length shift and transmission for the lens.
- c. Edge thicknesses given here are nominal and may vary from optic to optic.
- d. Suggested Fixed Lens Mounts: MLH05(M) or LMR05(M) with LMR8 Adapter
- e. Suggested Fixed Lens Mounts: MLH8(M) or LMR8(M)

Part Number	Description	Price	Availability
AC080-010-A	f = 10 mm, Ø8 mm Achromatic Doublet, ARC: 400 - 700 nm	\$50.06	Today
AC080-016-A	f = 16 mm, Ø8 mm Achromatic Doublet, ARC: 400 - 700 nm	\$49.51	Today
AC080-020-A	f = 20 mm, Ø8 mm Achromatic Doublet, ARC: 400 - 700 nm	\$48.97	Today
AC080-030-A	Customer Inspired!&nbsp;f = 30 mm, Ø8 mm Achromatic Doublet, ARC: 400 - 700 nm	\$48.01	Today

[Hide Ø1/2" \(Ø12.7 mm\) Unmounted Positive and Negative Achromatic Doublets, ARC: 400 - 700 nm](#)

**Ø1/2" (Ø12.7 mm) Unmounted Positive and Negative Achromatic Doublets, ARC: 400 - 700 nm**

Item #	Diameter (mm)	f <sup>a</sup> (mm)	f <sub>b</sub> <sup>a</sup> (mm)	Graphs <sup>b</sup>	R <sub>1</sub> <sup>a</sup> (mm)	R <sub>2</sub> <sup>a</sup> (mm)	R <sub>3</sub> <sup>a</sup> (mm)	t <sub>c1</sub> (mm)	t <sub>c2</sub> (mm)	t <sub>e</sub> <sup>c</sup> (mm)	Materials	Reference Drawing
ACN127-050-A <sup>d,e</sup>	12.7	-50.0	-52.3		-25.6	25.6	372.7	1.5	2.2	4.6	N-BAK4/SF5	
ACN127-030-A <sup>d,f</sup>	12.7	-30.0	-32.2		-16.2	16.5	154.2	1.5	2.3	5.2	N-BAK4/SF5	
ACN127-025-A <sup>d,f</sup>	12.7	-25.0	-27.0		-16.9	16.5	97.7	1.5	2.5	5.4	N-BAF10/N-SF6HT	
ACN127-020-A <sup>d,g</sup>	12.7	-20.0	-22.3		-13.5	14.3	87.9	1.5	3.0	6.3	N-BAF10/N-SF6HT	
AC127-019-A <sup>d,e</sup>	12.7	19.0	15.7		12.9	-11.0	-59.3	4.5	1.5	4.0	N-BAF10/N-SF6HT	
AC127-025-A <sup>f,g</sup>	12.7	25.0	21.5		18.8	-10.6	-68.1	5.0	2.0	5.6	N-BAF10/N-SF10	
AC127-030-A <sup>d,e</sup>	12.7	30.0	27.5		17.9	-13.5	-44.2	3.5	1.5	3.4	N-BK7/SF2	
AC127-050-A <sup>d,e</sup>	12.7	50.0	47.2		27.4	-22.5	-91.8	3.5	1.5	4.0	N-BK7/SF2	
AC127-075-A <sup>d,e</sup>	12.7	75.0	72.9		41.3	-34.0	-137.1	2.5	1.5	3.4	N-BK7/SF2	

- a. Positive values are measured from the right side of the lens as shown in the reference drawing. Negative values are measured from the left side of the lens.
- b. Click on for plots and downloadable data of the focal length shift and transmission for the lens.
- c. Edge thicknesses given here are nominal and may vary from optic to optic.
- d. Suggested Fixed Lens Mount: MLH05(M)
- e. Suggested Fixed Lens Mount: LMR05(M)
- f. Suggested Fixed Lens Mount: LMR05(M) with an SM05L03 Lens Tube
- g. Suggested Fixed Lens Mount: MLH05(M) with an SM05L03 Lens Tube

Part Number	Description	Price	Availability
ACN127-050-A	f = -50 mm, Ø1/2" Achromatic Doublet, ARC: 400 - 700 nm	\$61.42	Today
ACN127-030-A	f = -30 mm, Ø1/2" Achromatic Doublet, ARC: 400 - 700 nm	\$61.42	Today
ACN127-025-A	f = -25 mm, Ø1/2" Achromatic Doublet, ARC: 400 - 700 nm	\$61.42	Today
ACN127-020-A	f = -20 mm, Ø1/2" Achromatic Doublet, ARC: 400 - 700 nm	\$61.42	Today
AC127-019-A	f = 19 mm, Ø1/2" Achromatic Doublet, ARC: 400 - 700 nm	\$55.19	Today
AC127-025-A	f = 25 mm, Ø1/2" Achromatic Doublet, ARC: 400 - 700 nm	\$55.19	Today
AC127-030-A	f = 30 mm, Ø1/2" Achromatic Doublet, ARC: 400 - 700 nm	\$55.19	Today
AC127-050-A	f = 50 mm, Ø1/2" Achromatic Doublet, ARC: 400 - 700 nm	\$55.19	Today
AC127-075-A	f = 75 mm, Ø1/2" Achromatic Doublet, ARC: 400 - 700 nm	\$55.19	Today

[Hide Ø1" \(Ø25.4 mm\) Unmounted Positive and Negative Achromatic Doublets, ARC: 400 - 700 nm](#)

**Ø1" (Ø25.4 mm) Unmounted Positive and Negative Achromatic Doublets, ARC: 400 - 700 nm**

Item #	Diameter (mm)	f <sup>a</sup> (mm)	f <sub>b</sub> <sup>a</sup> (mm)	Graphs <sup>b</sup>	R <sub>1</sub> <sup>a</sup> (mm)	R <sub>2</sub> <sup>a</sup> (mm)	R <sub>3</sub> <sup>a</sup> (mm)	t <sub>c1</sub> (mm)	t <sub>c2</sub> (mm)	t <sub>e</sub> <sup>c</sup> (mm)	Materials	Reference Drawing
ACN254-100-A <sup>d</sup>	25.4	-100.1	-103.6		-52.0	49.9	600.0	2.0	4.0	7.7	N-BAK4/SF5	
ACN254-075-A <sup>d</sup>	25.4	-75.1	-78.8		-39.0	39.2	489.8	2.0	4.3	8.6	N-BAK4/SF5	
ACN254-050-A <sup>d</sup>	25.4	-50.0	-53.2		-34.0	32.5	189.2	2.0	4.5	9.4	N-BAF10/N-SF6HT	
ACN254-040-A <sup>d</sup>	25.4	-40.1	-43.6		-27.1	27.1	189.2	2.0	5.0	10.6	N-BAF10/N-SF11	
AC254-030-A <sup>d</sup>	25.4	30.0	22.9		20.9	-16.7	-79.8	12.0	2.0	8.8	N-BAF10/N-SF6HT	
AC254-035-A <sup>d</sup>	25.4	35.2	27.3		24.0	-19.1	-102.1	12.0	2.0	9.6	N-BAF10/N-SF6HT	
AC254-040-A <sup>d</sup>	25.4	40.1	33.4		23.7	-20.1	-57.7	10.0	2.5	7.4	N-BK7/SF5	
AC254-045-A <sup>e</sup>	25.4	45.0	40.2		31.2	-25.9	-130.6	7.0	2.0	5.7	N-BAF10/N-SF6HT	
AC254-050-A <sup>d</sup>	25.4	50.2	43.4		33.3	-22.3	-291.1	9.0	2.5	8.7	N-BAF10/N-SF10	
AC254-060-A <sup>d</sup>	25.4	60.1	54.3		41.7	-25.9	-230.7	8.0	2.5	8.2	E-BAF11/FD10	
AC254-075-A <sup>e</sup>	25.4	74.9	70.3		46.5	-33.9	-95.5	7.0	2.5	6.9	N-BK7/SF5	

AC254-080-A <sup>d</sup>	25.4	80.0	75.3		49.6	-35.5	-101.2	7.0	3.0	7.3	N-BK7/N-SF5	
AC254-100-A <sup>e</sup>	25.4	100.1	97.1		62.8	-45.7	-128.2	4.0	2.5	4.7	N-BK7/SF5	
AC254-125-A <sup>e</sup>	25.4	125.0	122.0		77.6	-55.9	-160.8	4.0	2.8	5.0	N-BK7/N-SF5	
AC254-150-A <sup>e</sup>	25.4	150.0	146.1		91.6	-66.7	-197.7	5.7	2.2	6.6	N-BK7/SF5	
AC254-200-A <sup>e</sup>	25.4	200.2	194.0		77.4	-87.6	291.1	4.0	2.5	5.7	N-SSK5/LAFN7	
AC254-250-A <sup>e</sup>	25.4	250.0	246.7		137.1	-111.5	-459.2	4.0	2.0	5.2	N-BK7/SF2	
AC254-300-A <sup>e</sup>	25.4	300.2	297.0		165.2	-137.1	-557.4	4.0	2.0	5.4	N-BK7/SF2	
AC254-400-A <sup>e</sup>	25.4	399.3	396.0		219.8	-181.6	-738.5	4.0	2.0	5.5	N-BK7/SF2	
AC254-500-A <sup>e</sup>	25.4	502.5	499.9		337.3	-186.8	-557.4	4.0	2.0	5.6	N-BK7/SF2	

- a. Positive values are measured from the right side of the lens as shown in the reference drawing. Negative values are measured from the left side of the lens.
- b. Click on for plots and downloadable data of the focal length shift and transmission for the lens.
- c. Edge thicknesses given here are nominal and may vary from optic to optic.
- d. Suggested Fixed Lens Mount: LMR1(/M) with an SM1L05 Lens Tube
- e. Suggested Fixed Lens Mount: LMR1(/M)

Part Number	Description	Price	Availability
ACN254-100-A	f = -100 mm, Ø1" Achromatic Doublet, ARC: 400 - 700 nm	\$92.26	Today
ACN254-075-A	f = -75 mm, Ø1" Achromatic Doublet, ARC: 400 - 700 nm	\$92.26	Today
ACN254-050-A	f = -50 mm, Ø1" Achromatic Doublet, ARC: 400 - 700 nm	\$92.26	Today
ACN254-040-A	f = -40 mm, Ø1" Achromatic Doublet, ARC: 400 - 700 nm	\$92.26	Today
AC254-030-A	f = 30 mm, Ø1" Achromatic Doublet, ARC: 400 - 700 nm	\$87.65	Today
AC254-035-A	f = 35 mm, Ø1" Achromatic Doublet, ARC: 400 - 700 nm	\$87.65	Today
AC254-040-A	f = 40 mm, Ø1" Achromatic Doublet, ARC: 400 - 700 nm	\$81.16	Today
AC254-045-A	f = 45 mm, Ø1" Achromatic Doublet, ARC: 400 - 700 nm	\$81.16	Today
AC254-050-A	f = 50 mm, Ø1" Achromatic Doublet, ARC: 400 - 700 nm	\$81.16	Today
AC254-060-A	f = 60 mm, Ø1" Achromatic Doublet, ARC: 400 - 700 nm	\$81.16	Today
AC254-075-A	f = 75 mm, Ø1" Achromatic Doublet, ARC: 400 - 700 nm	\$81.16	Today
AC254-080-A	Customer Inspired!&nbsp;f = 80 mm, Ø1" Achromatic Doublet, ARC: 400 - 700 nm	\$81.16	5-8 Days
AC254-100-A	f = 100 mm, Ø1" Achromatic Doublet, ARC: 400 - 700 nm	\$81.16	Today
AC254-125-A	Customer Inspired!&nbsp;f = 125 mm, Ø1" Achromatic Doublet, ARC: 400 - 700 nm	\$81.16	Today
AC254-150-A	f = 150 mm, Ø1" Achromatic Doublet, ARC: 400 - 700 nm	\$81.16	5-8 Days
AC254-200-A	f = 200 mm, Ø1" Achromatic Doublet, ARC: 400 - 700 nm	\$81.16	Today
AC254-250-A	f = 250 mm, Ø1" Achromatic Doublet, ARC: 400 - 700 nm	\$81.16	Today
AC254-300-A	f = 300 mm, Ø1" Achromatic Doublet, ARC: 400 - 700 nm	\$81.16	Today
AC254-400-A	f = 400 mm, Ø1" Achromatic Doublet, ARC: 400 - 700 nm	\$81.16	Today
AC254-500-A	f = 502 mm, Ø1" Achromatic Doublet, ARC: 400 - 700 nm	\$81.16	Today

[Hide Ø30.0 mm Unmounted Positive Achromatic Doublets, AR Coated: 400 - 700 nm](#)

**Ø30.0 mm Unmounted Positive Achromatic Doublets, AR Coated: 400 - 700 nm**

Item #	Diameter (mm)	f <sup>a</sup> (mm)	f <sub>b</sub> <sup>a</sup> (mm)	Graphs <sup>b</sup>	R <sub>1</sub> <sup>a</sup> (mm)	R <sub>2</sub> <sup>a</sup> (mm)	R <sub>3</sub> <sup>a</sup> (mm)	t <sub>c1</sub> (mm)	t <sub>c2</sub> (mm)	t <sub>e</sub> <sup>c</sup> (mm)	Materials	Reference Drawing
AC300-050-A <sup>d</sup>	30.0	50.0	44.3		34.0	-29.4	-161.5	8.5	2.0	6.3	N-BAF10/N-SF6HT	
AC300-080-A <sup>d</sup>	30.0	80.0	74.3		56.0	-44.2	-219.8	8.5	2.0	7.9	N-BAF10/N-SF6HT	
AC300-100-A <sup>e</sup>	30.0	100.0	96.4		70.0	-57.0	-284.4	5.0	2.0	5.0	N-BAF10/N-SF6HT	

- a. Positive values are measured from the right side of the lens as shown in the reference drawing. Negative values are measured from the left side of the lens.
- b. Click on for plots and downloadable data of the focal length shift and transmission for the lens.
- c. Edge thicknesses given here are nominal and may vary from optic to optic.
- d. Suggested Fixed Lens Mount: LMR30(/M) with an SM30L03 Lens Tube
- e. Suggested Fixed Lens Mount: LMR30(/M)

Part Number	Description	Price	Availability
AC300-050-A	f = 50 mm, Ø30 mm Achromatic Doublet, ARC: 400 - 700 nm	\$91.98	Today
AC300-080-A	f = 80 mm, Ø30 mm Achromatic Doublet, ARC: 400 - 700 nm	\$91.98	Today
AC300-100-A	f = 100 mm, Ø30 mm Achromatic Doublet, ARC: 400 - 700 nm	\$91.98	Today

[Hide Ø2" \(Ø50.8 mm\) Unmounted Positive Achromatic Doublets, AR Coated: 400 - 700 nm](#)

**Ø2" (Ø50.8 mm) Unmounted Positive Achromatic Doublets, AR Coated: 400 - 700 nm**

Item #	Diameter (mm)	f <sup>a</sup> (mm)	f <sub>b</sub> <sup>a</sup> (mm)	Graphs <sup>b</sup>	R <sub>1</sub> <sup>a</sup> (mm)	R <sub>2</sub> <sup>a</sup> (mm)	R <sub>3</sub> <sup>a</sup> (mm)	t <sub>c1</sub> (mm)	t <sub>c2</sub> (mm)	t <sub>e</sub> <sup>c</sup> (mm)	Materials	Reference Drawing
AC508-075-A <sup>d</sup>	50.8	74.9	61.8		50.8	-41.7	-247.7	20.0	3.0	14.9	E-BAF11/N-SF11	
AC508-080-A <sup>d</sup>	50.8	80.0	69.9		54.9	-46.4	-247.2	16.0	2.0	10.5	N-BAF10/N-SF6HT	

AC508-100-A <sup>d</sup>	50.8	100.0	89.0		71.1	-44.2	-363.1	16.0	4.0	14.4	N-BAF10/N-SF10	
AC508-150-A <sup>d</sup>	50.8	150.0	140.4		83.2	-72.1	-247.7	12.0	3.0	9.7	N-BK7/SF5	
AC508-180-A <sup>e,f</sup>	50.8	180.0	172.7		109.7	-80.7	-238.5	12.0	2.0	9.4	N-BK7/N-SF5	
AC508-200-A <sup>e,f</sup>	50.8	200.0	193.7		109.9	-93.1	-376.3	8.5	2.0	6.7	N-BK7/SF2	
AC508-250-A <sup>g</sup>	50.8	250.0	244.6		137.1	-111.7	-459.2	7.5	2.0	6.4	N-BK7/SF2	
AC508-300-A <sup>g</sup>	50.8	300.0	295.4		161.5	-134.0	-580.8	6.0	2.0	5.4	N-BK7/SF2	
ACT508-400-A <sup>d</sup>	50.8	400.0	394.6		292.3	-148.9	-398.5	8.0	8.0	14.1	N-BK7/N-SF2	
AC508-500-A <sup>g</sup>	50.8	500.0	495.8		272.9	-234.3	-970.0	5.0	2.0	5.5	N-BK7/SF2	
ACT508-750-A <sup>d</sup>	50.8	750.0	743.9		398.6	-343.7	-1544.5	6.0	6.0	11.0	N-BK7/N-SF2	
AC508-1000-A <sup>g</sup>	50.8	1000.0	994.6		738.5	-398.1	-1023.3	4.0	2.0	5.2	N-BK7/SF2	

a. Positive values are measured from the right side of the lens as shown in the reference drawing. Negative values are measured from the left side of the lens.

b. Click on for plots and downloadable data of the focal length shift and transmission for the lens.

c. Edge thicknesses given here are nominal and may vary from optic to optic.

d. Suggested Fixed Lens Mount: LMR2(/M) with SM2L10 Lens Tube

e. Suggested Fixed Lens Mount: LMR2(/M) with SM2L05 Lens Tube

f. Common microscope tube lens focal lengths. We also offer an infinity corrected tube lens with  $f = 200$  mm here.

g. Suggested Fixed Lens Mount: LMR2(/M)

Part Number	Description	Price	Availability
AC508-075-A	f = 75 mm, Ø2" Achromatic Doublet, ARC: 400 - 700 nm	\$128.77	Today
AC508-080-A	f = 80 mm, Ø2" Achromatic Doublet, ARC: 400 - 700 nm	\$128.77	Today
AC508-100-A	f = 100 mm, Ø2" Achromatic Doublet, ARC: 400 - 700 nm	\$112.54	Today
AC508-150-A	f = 150 mm, Ø2" Achromatic Doublet, ARC: 400 - 700 nm	\$112.54	Today
AC508-180-A	Customer Inspired!&nbsp;f = 180 mm, Ø2" Achromatic Doublet, ARC: 400 - 700 nm	\$112.54	5-8 Days
AC508-200-A	f = 200 mm, Ø2" Achromatic Doublet, ARC: 400 - 700 nm	\$112.54	Today
AC508-250-A	f = 250 mm, Ø2" Achromatic Doublet, ARC: 400 - 700 nm	\$112.54	5-8 Days
AC508-300-A	f = 300 mm, Ø2" Achromatic Doublet, ARC: 400 - 700 nm	\$112.54	Today
ACT508-400-A	NEW! Customer Inspired!&nbsp;f = 400 mm, Ø2" Achromatic Doublet, ARC: 400 - 700 nm	\$115.00	Today
AC508-500-A	f = 500 mm, Ø2" Achromatic Doublet, ARC: 400 - 700 nm	\$112.54	Today
ACT508-750-A	NEW! Customer Inspired!&nbsp;f = 750 mm, Ø2" Achromatic Doublet, ARC: 400 - 700 nm	\$115.00	Today
AC508-1000-A	f = 1000 mm, Ø2" Achromatic Doublet, ARC: 400 - 700 nm	\$112.54	5-8 Days