

352240-B - June 22, 2018

Item # 352240-B was discontinued on June 22, 2018. For informational purposes, this is a copy of the website content at that time and is valid only for the stated product.

MOLDED GLASS ASPHERIC LENSES, 600 - 1050 OR 650 - 1050 NM AR COATING

- ▶ High NA (0.15 to 0.68)
- ▶ Diffraction-Limited Performance
- ▶ Broadband AR-Coated Optics in Stock
- ▶ Collimate or Focus Light with a Single Element

Application Idea
 Aspheric Lens in a Fiber Launch Application



OVERVIEW

Molded Glass Aspheric Lenses: 600 - 1050 nm or 650 - 1050 nm Broadband AR Coating

Aspheric lenses focus or collimate light without introducing spherical aberration into the transmitted wavefront. For monochromatic sources, spherical aberration often prevents a single spherical lens from achieving diffraction-limited performance when focusing or collimating light. Thus, an aspheric lens is often the best single element solution for many applications including collimating the output of a fiber or laser diode, coupling light into a fiber, spatial filtering, or imaging light onto a detector.

All of these molded glass lenses are manufactured by LightPath® and are available premounted in non-magnetic 303 stainless steel lens cells that are engraved with the part number for easy identification. These mounted aspheres have a metric thread that makes them easy to integrate into an optical setup or OEM application. The mounted aspheres are readily adapted to our SM1-threaded (1.035"-40) of lens tubes by using our Aspheric Lens Adapters. Mounted aspheres can be used as a drop-in replacement for multi-element microscope objectives by combining the lens with our Microscope Objective Adapter Extension Tube.

Alternative Aspheric Lenses	
Coating Designation	Spectral Range
Uncoated	Visible and NIR
-A	350 - 700 nm
-B	600 - 1050 nm
-C	1050 - 1620 nm
-D	1.8 - 3 μm
-E	3 - 5 μm
-F	8 - 12 μm
-405	405 nm
-1064	1064 nm

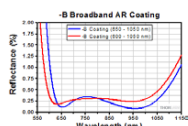

Click to Enlarge

If an unmounted aspheric lens is being used to collimate the light from a point source or laser diode, the side with the greater radius of curvature (i.e., the flatter surface) should face the point source or laser diode. To collimate light using one of our mounted aspheric lenses, orient the housing so that the externally threaded end of the mount faces the source.

Molded glass aspheres are manufactured from a variety of optical glasses to yield the indicated performance. The molding process

[Click Here to Download Raw Data](#)

will cause the properties of the glass (e.g., Abbe number) to deviate slightly from those given by glass manufacturers. Specific material properties for each lens can be found by clicking on the Glass link in the tables below. Other LightPath aspheric lenses are also available; refer to the Alternative Aspheric Lenses table above to explore.

Webpage Features	
	Click to view complete specifications, documents, and drawings.
Performance Hyperlink	Click to view item specific spot diagrams at various wavelengths and focal length shift data.

FIBER COUPLING

Choosing a Lens

Aspheric lenses are commonly chosen to couple incident light with a diameter of 1 - 5 mm into a single mode fiber. A simple example will illustrate the key specifications to consider when trying to choose the correct lens.

Example:

Fiber: P1-630A-FC-2

Collimated Beam Diameter Prior to Lens: Ø3 mm

The specifications for the P1-630A-FC-2, 630 nm, FC/PC single mode patch cable indicate that the mode field diameter (MFD) is 4.3 µm. This specification should be matched to the diffraction-limited spot size given by the following equation:

$$\phi_{spot} = \frac{4\lambda f}{\pi D}$$

Here, f is the focal length of the lens, λ is the wavelength of the input light, and D is the diameter of collimated beam incident on the lens. Solving for the desired focal length of the collimating lens yields

$$f = \frac{\pi D(MFD)}{4\lambda} = \frac{\pi(0.003\text{m})(4.3 \times 10^{-6}\text{m})}{4(630 \times 10^{-9}\text{m})} = 0.016\text{m} = 16\text{mm}$$

Thorlabs offers a large selection of mounted and unmounted aspheric lenses to choose from. The aspheric lens with a focal length that is closest to 16 mm has a focal length of 15.29 mm (Item# 354260-B or A260-B). This lens also has a clear aperture that is larger than the collimated beam diameter. Therefore, this aspheric lens is the best option given the initial parameters (i.e., a P1-630A-FC-2 single mode fiber and a collimated beam diameter of 3 mm). Remember, for optimum coupling the spot size of the focused beam must be less than the MFD of the single mode fiber. As a result, if an aspheric lens is not available that provides an exact match, then choose the aspheric lens with a focal length that is shorter than the calculation above yields. Alternatively, if the clear aperture of the aspheric lens is large enough, the beam can be expanded before the aspheric lens, which has the result of reducing the spot size of the focus beam.

Aspheric Lens Design Formula

- Positive Radius Indicates that the Center of Curvature is to the Right of the Lens
- Negative Radius Indicates that the Center of Curvature is to the Left of the Lens

$$z = \frac{Y^2}{R \left(1 + \sqrt{1 - (1+k) \frac{Y^2}{R^2}} \right)} + A_4 Y^4 + A_6 Y^6 + \dots + A_n Y^n$$

Aspheric Lens Equation

Definitions of Variables	
z	Sag (Surface Profile)
Y	Radial Distance from Optical Axis
R	Radius of Curvature
k	Conic Constant
A ₄	4th Order Aspheric Coefficient
A ₆	6th Order Aspheric Coefficient
A _n	nth Order Aspheric Coefficient

The target values of these constants are available by clicking on the Info Icons below or by viewing the .pdf and .dxf files available for each lens. Links to the files can be found under the Drawings and Documents tab or by clicking on the part number in the price tables below.

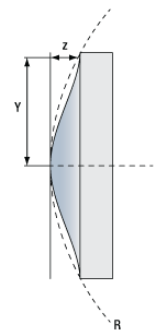

[Click to Enlarge Reference Drawing](#)

COLLIMATION TUTORIAL

Choosing a Collimation Lens for Your Laser Diode

Since the output of a laser diode is highly divergent, collimating optics are necessary. Since aspheric lenses do not introduce spherical aberration, they are commonly chosen when the collimated laser beam is to be between one and five millimeters. A simple example will illustrate the key specifications to consider when choosing the correct lens for a given application.

Example:

Laser Diode to be Used: L780P010

Desired Collimated Beam Diameter: Ø3 mm (Major Axis)

The specifications for the L780P010 laser diode indicate that the typical parallel and perpendicular FWHM beam divergences are 10° and 30°, respectively. Therefore, as the light diverges, an elliptical beam will result. To collect as much light as possible during the collimation process, consider the larger of these two divergence angles in any calculations (i.e., in this case use 30°). If you wish to convert your elliptical beam in to a round one, we suggest using an Anamorphic Prism Pair, which magnifies one axis of your beam.

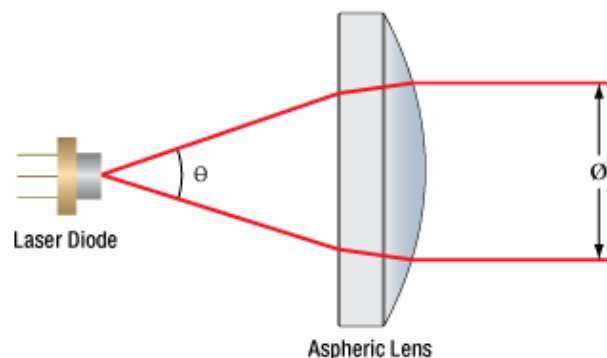

Ø = Beam Diameter Θ = Divergence Angle

From the information above, the focal length of the lens can be determined, using the thin lens approximation:

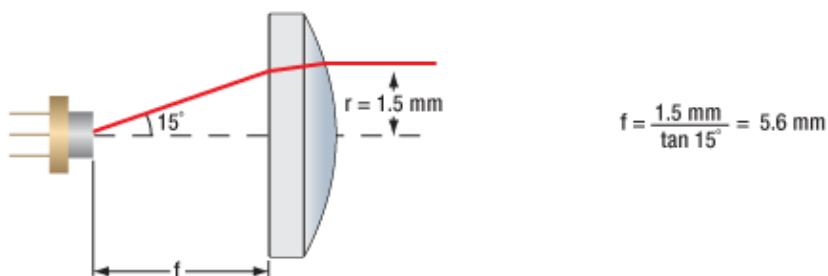

With this information known, it is now time to choose the appropriate collimating lens. Thorlabs offers a large selection of aspheric lenses to choose from. For this application the ideal lens is a -B AR-coated molded glass aspheric lens with focal length near 5.6 mm. The C171TMD-B (mounted) or 354171-B (unmounted) aspheric lenses have a focal length of 6.20 mm, which will result in a collimated beam diameter (major axis) of 3.3 mm. Next, check to see if the numerical aperture (NA) of the diode is smaller than the NA of the lens:

$$0.30 = NA_{\text{Lens}} > NA_{\text{Diode}} \approx \sin(15^\circ) = 0.26$$

Up to this point, we have been using the FWHM beam diameter to characterize the beam. However, a better practice is to use the $1/e^2$ beam diameter. For a Gaussian beam profile, the $1/e^2$ diameter is almost equal to 1.7X the FWHM diameter. The $1/e^2$ beam diameter therefore captures more of the laser diode's output light (for greater power delivery) and minimizes far-field diffraction (by clipping less of the incident light).

A good rule of thumb is to pick a lens with an NA twice of the NA of the laser diode. For example, either the A390-B or the A390TM-B could be used as these lenses each have an NA of 0.53, which is more than twice the approximate NA of our laser diode (0.26). Note that these lenses each have a focal length of 4.6 mm, resulting in an approximate major beam diameter of 2.5 mm.

SELECTION GUIDE

The table below contains all molded visible and near-IR aspheric lenses offered by Thorlabs. For our selection of IR molded aspheres, click [here](#). The item # listed is that of the unmounted, uncoated lens. An "X" in any of the five AR Coating Columns indicates the lens is available with that coating (note that the V coating availability is indicated with the design wavelength). The table to the right defines each letter and lists the specified AR coating range. Click on the linked X's to purchase the specific lens, which is available mounted and unmounted.



AR Coating Abbreviations	
Abbreviation	Description
U	Uncoated: Optics do not have an AR Coating of any kind
A	Broadband AR Coating for the 350 - 700 nm or 400 - 600 nm range
B	Broadband AR Coating for the 600 - 1050 nm or 650 - 1050 nm range
C	Broadband AR Coating for the 1050 - 1620 nm range
V	Narrowband AR Coating designed for the wavelength listed in the table below

Base Item #	AR Coating Options					Effective Focal Length	NA	Outer Diameter of Unmounted Lens	Working Distance		Clear Aperture of Unmounted Lens
	U	A	B	C	V				Unmounted	Mounted ^a	
354140		X	X	X		1.45 mm	0.58	2.4 mm	0.81 mm	0.81 mm	1.60 mm
354710		X	X	X		1.49 mm	0.53	2.7 mm	0.52 mm ^b	0.42 mm ^b	1.50 mm
355151		X	X	X		2.00 mm	0.50	3.00 mm	0.48 mm ^b	0.28 mm ^b	2.00 mm
355390		X	X	X		2.75 mm	0.55	4.50 mm	2.16 mm	1.91 mm	3.60 mm
355392		X	X	X		2.75 mm	0.64	4.00 mm	1.50 mm	0.98 mm	3.60 mm
355440		X	X	X		2.76 mm	0.26/0.52 ^c	4.7 mm	1.96 mm/7.09 mm ^{b,c}	1.86 mm/7.09 mm ^{b,c}	4.12 mm

355660		X	X	X		2.97 mm	0.60	4.00 mm	1.56 mm	1.31 mm	3.60 mm
354330		X	X	X		3.1 mm	0.68	6.3 mm	1.76 mm	1.76 mm	5.00 mm
A414			X	X		3.30 mm	0.47	4.50 mm	1.94 mm	1.81 mm	3.52 mm
N414		X	X	X		3.30 mm	0.47	4.50 mm	1.94 mm	1.83 mm	3.52 mm
352610		X	X			4.00 mm	0.60	6.33 mm	2.73 mm	2.44 mm	4.80 mm
352671		X	X		405	4.02 mm	0.60	6.33 mm	2.37 mm	2.13 mm	4.80 mm
354340		X	X			4.03 mm	0.64	6.3 mm	1.48 mm ^b	1.18 mm ^b	5.10 mm
354350			X	X		4.50 mm	0.43	4.70 mm	2.19 mm	1.59 mm	3.70 mm
352110					1064	6.24 mm	0.40	7.20 mm	3.39 mm	2.42 mm	5.00 mm
355230		X	X	X		4.51 mm	0.55	6.30 mm	2.83 mm ^b	2.43 mm ^b	5.07 mm
A230	X	X	X	X		4.51 mm	0.55	6.34 mm	2.91 mm	2.53 mm	4.95 mm
A390		X	X			4.60 mm	0.53	6.00 mm	2.70 mm	1.64 mm	4.89 mm
354430			X	X		5.00 mm	0.16	2.00 mm	4.37 mm	3.37 mm	1.60 mm
354171		X	X	X		6.20 mm	0.30	4.70 mm	3.44 mm ^b	2.84 mm ^b	3.70 mm
352230					1064	4.51 mm	0.55	6.33 mm	2.92 mm	2.67 mm	4.95 mm
355110		X	X	X		6.24 mm	0.40	7.20 mm	2.69 mm ^b	1.59 mm ^b	5.00 mm
A110	X	X	X	X		6.24 mm	0.40	7.20 mm	3.39 mm	2.39 mm	5.00 mm
A375		X	X	X		7.50 mm	0.30	6.51 mm	5.90 mm	5.59 mm	4.50 mm
352240		X	X	X	1064	8.00 mm	0.50	9.94 mm	5.92 mm	4.93 mm	8.00 mm
A240	X	X	X	X		8.00 mm	0.50	9.94 mm	5.92 mm	4.79 mm	8.00 mm
A397		X	X	X		11.00 mm	0.30	7.20 mm	9.64 mm	8.44 mm	6.59 mm
A220	X	X	X			11.00 mm	0.26	7.20 mm	7.97 mm	6.91 mm	5.50 mm
352220					1064	11.00 mm	0.25	7.22 mm	7.97 mm	6.83 mm	5.50 mm
354220		X	X	X		11.00 mm	0.25	7.2 mm	6.91 mm ^b	5.81 mm ^b	5.50 mm
354560		X	X	X		13.86 mm	0.18	6.33 mm	12.11 mm	11.74 mm	5.10 mm
354260		X	X	X		15.29 mm	0.16	6.50 mm	12.73 mm ^b	12.43 mm ^b	5.00 mm
A260		X	X	X		15.29 mm	0.16	6.50 mm	14.09 mm	13.84 mm	5.00 mm
352280					1064	18.40 mm	0.15	6.50 mm	17.13 mm	16.75 mm	5.50 mm
354280		X	X	X		18.40 mm	0.15	6.5 mm	15.86 mm ^b	15.56 mm ^b	5.50 mm
A280		X	X	X		18.40 mm	0.15	6.50 mm	17.13 mm	16.88 mm	5.50 mm

- a. The mounted working distance is measured from the edge of the unthreaded portion of the housing.
b. The working distance is measured to the edge of the laser diode window (instead of the emission point).
c. Image/ Object

EFL = 1.xx mm

Item # (Unmounted /Mounted)	Info	EFL ^a	NA	OD	CA	WD ^b	DW	AR Range	M	Glass	Performance	Thread	Suggested Spanner Wrench
354140-B		1.45 mm	0.58	2.4 mm	1.60 mm	0.81 mm	780 nm	600 - 1050 nm	∞	D-ZK3	Focal Shift	-	-
C140TMD-B				6.2 mm		0.81 mm					Spot Size Cross Section	M6 x 0.5	SPW306
354710-B		1.49 mm	0.53	2.7 mm	1.50 mm	0.52 mm ^c	1550 nm	600 - 1050 nm	∞	D-ZK3	Focal Shift	-	-
C710TMD-B				6.2 mm		0.42 mm ^c					Spot Size Cross Section	M6 x 0.5	SPW306

- a. EFL is specified at the design wavelength for the unmounted lens.
b. WD is specified at the design wavelength.
c. This working distance is measured from the lens to the window of the laser diode being collimated (not the emission point).
- EFL = Effective Focal Length
NA = Numerical Aperture
CA = Clear Aperture
WD = Working Distance
DW = Design Wavelength

OD = Outer Diameter
M = Magnification

Part Number	Description	Price	Availability
354140-B	f = 1.45 mm, NA = 0.58, Unmounted Geltech Aspheric Lens, AR: 600-1050 nm	\$50.24	Today
C140TMD-B	f = 1.45 mm, NA = 0.58, Mounted Geltech Aspheric Lens, AR: 600-1050 nm	\$77.78	Today
354710-B	f = 1.49 mm, NA = 0.53, Unmounted Geltech Aspheric Lens, AR: 600-1050 nm	\$62.73	Today
C710TMD-B	f = 1.49 mm, NA = 0.53, Mounted Geltech Aspheric Lens, AR: 600-1050 nm	\$83.13	Today

EFL = 2.xx mm

Item # (Unmounted / Mounted)	Info	EFL ^a	NA	OD	CA	WD ^b	DW	AR Range	M	Glass	Performance	Thread	Suggested Spanner Wrench
355151-B		2.00 mm	0.50	3.0 mm	2.00 mm	0.48 mm ^c	780 nm	600 - 1050 nm	∞	D-ZLaF52LA	Focal Shift Spot Size Cross Section	-	-
C151TMD-B				6.2 mm		0.28 mm ^c						M6 x 0.5	SPW306
355390-B		2.75 mm	0.55	4.50 mm	3.60 mm	2.16 mm	830 nm	600 - 1050 nm	∞	D-ZLaF52LA	390_Asph.pdf	-	-
C390TME-B				8.21 mm		1.91 mm						M8 x 0.5	SPW308
355392-B		2.75 mm	0.64	4.0 mm	3.60 mm	1.50 mm	830 nm	650 - 1050 nm	∞	D-ZLaF52LA	392_Asph.pdf	-	-
C392TME-B				6.2 mm		0.98 mm						M6 x 0.5	SPW306
355440-B		2.76 mm	0.26 ^d 0.52 ^e	4.7 mm	4.12 mm	1.96 mm ^{c,d} 7.09 mm ^{c,e}	980 nm	600 - 1050 nm	2	D-ZLaF52LA	Focal Shift Spot Size Cross Section	-	-
C440TMD-B				8.2 mm		1.86 mm ^{c,d} 7.09 mm ^{c,e}						M8 x 0.5	SPW308
355660-B		2.97 mm	0.60	4.00 mm	3.60 mm	1.56 mm	1550 nm	600 - 1050 nm	∞	D-ZLaF52LA	660_Asph.pdf	-	-
C660TME-B				8.20 mm		1.31 mm						M8 x 0.5	SPW308

a. EFL is specified at the design wavelength for the unmounted lens.
b. WD is specified at the design wavelength.
c. This working distance is measured from the lens to the to the window of the laser diode being collimated (not the emission point).
d. Image side.
e. Object side.

EFL = Effective Focal Length
NA = Numerical Aperture
CA = Clear Aperture

WD = Working Distance
DW = Design Wavelength
OD = Outer Diameter
M = Magnification

Part Number	Description	Price	Availability
355151-B	f = 2.00 mm, NA = 0.50, Unmounted Geltech Aspheric Lens, AR: 600-1050 nm	\$57.12	Today
C151TMD-B	f = 2.00 mm, NA = 0.50, Mounted Geltech Aspheric Lens, AR: 600-1050 nm	\$84.92	Today
355390-B	f = 2.75 mm, NA = 0.55, Unmounted Geltech Aspheric Lens, AR: 600-1050 nm	\$74.21	Today
C390TME-B	f = 2.75 mm, NA = 0.55, Mounted Geltech Aspheric Lens, AR: 600-1050 nm	\$79.31	Today
355392-B	Customer Inspired! f = 2.75 mm, NA = 0.64, Unmounted Geltech Aspheric Lens, AR: 650-1050 nm	\$74.21	Today
C392TME-B	Customer Inspired! f = 2.75 mm, NA = 0.64, Mounted Geltech Aspheric Lens, AR: 650-1050 nm	\$79.31	Today
355440-B	f = 2.76 mm, NA = 0.26/0.52, Unmounted Geltech Aspheric Lens, AR: 600-1050 nm	\$53.81	Today
C440TMD-B	f = 2.76 mm, NA = 0.26/0.52, Mounted Geltech Aspheric Lens, AR: 600-1050 nm	\$71.66	Today

355660-B	f = 2.97 mm, NA = 0.60, Unmounted Geltech Aspheric Lens, AR: 600-1050 nm	\$87.98	Today
C660TME-B	f = 2.97 mm, NA = 0.60, Mounted Geltech Aspheric Lens, AR: 600-1050 nm	\$93.33	Today

EFL = 3.xx mm

Item # (Unmounted / Mounted)	Info	EFL ^a	NA	OD	CA	WD ^b	DW	AR Range	M	Glass	Performance	Thread	Suggested Spanner Wrench
354330-B		3.1 mm	0.7	6.33 mm	S1: 5.00 mm S2: 3.84 mm	1.8 mm	830 nm	600 - 1050 nm	∞	D-ZK3	Focal Shift Spot Size Cross Section	-	-
C330TMD-B				9.24 mm		1.8 mm						M9 x 0.5	SPW301
N414-B		3.30 mm	0.47	4.50 mm	3.52 mm	1.94 mm	670 nm	650 - 1050 nm	∞	H-ZLAF52	N414_Asph.pdf	-	-
N414TM-B				6.22 mm		1.83 mm						M6 x 0.5	SPW306
A414TM-B		3.30 mm	0.47	6.22 mm	3.52 mm	1.81 mm	670 nm	650 - 1050 nm	∞	N-SF57	A414_Asph.pdf	M6 x 0.5	SPW306

a. EFL is specified at the design wavelength for the unmounted lens.
b. WD is specified at the design wavelength.

EFL = Effective Focal Length
NA = Numerical Aperture
CA = Clear Aperture

WD = Working Distance
DW = Design Wavelength

OD = Outer Diameter
M = Magnification

Part Number	Description	Price	Availability
354330-B	f = 3.1 mm, NA = 0.7, Unmounted Geltech Aspheric Lens, AR: 600-1050 nm	\$62.73	Today
C330TMD-B	f = 3.1 mm, NA = 0.7, Mounted Geltech Aspheric Lens, AR: 600-1050 nm	\$77.78	Today
N414-B	f = 3.30 mm, NA = 0.47, Unmounted Rochester Aspheric Lens, AR: 650-1050 nm	\$87.47	Today
N414TM-B	f = 3.30 mm, NA = 0.47, Mounted Rochester Aspheric Lens, AR: 650-1050 nm	\$92.82	Today
A414TM-B	f = 3.30 mm, NA = 0.47, Mounted Rochester Aspheric Lens, AR: 650-1050 nm	\$70.64	Today

EFL = 4.xx mm

Item # (Unmounted / Mounted)	Info	EFL ^a	NA	OD	CA	WD ^b	DW	AR Range	M	Glass	Performance	Thread	Suggested Spanner Wrench
352610-B		4.00 mm	0.60	6.33 mm	4.80 mm	2.73 mm	410 nm	600 - 1050 nm	∞	ECO-550	610_Asph.pdf	-	-
C610TME-B				9.24 mm		2.44 mm						M9 x 0.5	SPW301
352671-B		4.02 mm	0.60	6.33 mm	4.80 mm	2.37 mm	408 nm	600 - 1050 nm	∞	ECO-550	671_Asph.pdf	-	-
C671TME-B				9.24 mm		2.13 mm						M9 x 0.5	SPW301
354340-B		4.03 mm	0.64	6.3 mm	5.10 mm	1.48 mm ^c	685 nm	600 - 1050 nm	∞	D-ZK3	Focal Shift Spot Size Cross Section	-	-
C340TMD-B				9.2 mm		1.18 mm						M9 x 0.5	SPW301
354350-B		4.50 mm	0.43	4.7 mm	3.70 mm	2.19 mm	980 nm	600 - 1050 nm	∞	D-ZK3	Focal Shift Spot Size Cross Section	-	-
C350TMD-B				8.2 mm		1.59 mm						M8 x 0.5	SPW308
355230-B		4.51 mm	0.55	6.3 mm	5.07 mm	2.83 mm ^c	780 nm	600 - 1050 nm	∞	D-ZLaF52LA	Focal Shift Spot Size Cross Section	-	-
C230TMD-B				9.2 mm		2.43 mm						M9 x 0.5	SPW301
A230-B		4.51 mm	0.55	6.34 mm	4.95 mm	2.91 mm	780 nm	650 - 1050 nm	∞	S-NPH1	A230_Asph.pdf	-	-

A230TM-B				9.24 mm		2.53 mm							M9 x 0.5	SPW301
A390-B	i	4.60 mm	0.53	6.00 mm	4.89 mm	2.70 mm	655 nm	650 - 1050 nm	∞	H-LAK54	A390_Asph.pdf	-	-	
A390TM-B				9.24 mm		1.64 mm						M9 x 0.5	SPW301	

- a. EFL is specified at the design wavelength for the unmounted lens.
b. WD is specified at the design wavelength.
c. This working distance is measured from the lens to the to the window of the laser diode being collimated (not the emission point).

EFL = Effective Focal Length
NA = Numerical Aperture
CA = Clear Aperture

WD = Working Distance
DW = Design Wavelength

OD = Outer Diameter
M = Magnification

Part Number	Description	Price	Availability
352610-B	f=4.0 mm, NA=0.6, Unmounted Geltech Aspheric Lens, AR: 600-1050 nm	\$87.98	Today
C610TME-B	f = 4.0 mm, NA = 0.6, Mounted Geltech Aspheric Lens, AR: 600-1050 nm	\$93.33	Today
352671-B	f = 4.02 mm, NA = 0.6, Unmounted Geltech Aspheric Lens, AR: 600-1050 nm	\$121.38	Today
C671TME-B	f = 4.02 mm, NA = 0.6, Mounted Geltech Aspheric Lens, AR: 600-1050 nm	\$127.50	Today
354340-B	f = 4.03 mm, NA = 0.64, Unmounted Geltech Aspheric Lens, AR: 600-1050 nm	\$62.73	Today
C340TMD-B	f = 4.03 mm, NA = 0.64, Mounted Geltech Aspheric Lens, AR: 600-1050 nm	\$77.78	Today
354350-B	f = 4.50 mm, NA = 0.43, Unmounted Geltech Aspheric Lens, AR: 600-1050 nm	\$54.32	Today
C350TMD-B	f = 4.50 mm, NA = 0.43, Mounted Geltech Aspheric Lens, AR: 600-1050 nm	\$72.42	Today
355230-B	f = 4.51 mm, NA = 0.55, Unmounted Geltech Aspheric Lens, AR: 600-1050 nm	\$53.81	Today
C230TMD-B	f = 4.51 mm, NA = 0.55, Mounted Geltech Aspheric Lens, AR: 600-1050 nm	\$68.85	Today
A230-B	f = 4.51 mm, NA = 0.55, Unmounted Rochester Aspheric Lens, AR: 650-1050 nm	\$79.31	Today
A230TM-B	f = 4.51 mm, NA = 0.55, Mounted Rochester Aspheric Lens, AR: 650-1050 nm	\$84.92	Today
A390-B	f = 4.6 mm, NA = 0.53, Unmounted Rochester Aspheric Lens, AR: 650-1050 nm	\$87.47	Today
A390TM-B	f = 4.6 mm, NA = 0.53, Mounted Rochester Aspheric Lens, AR: 650-1050 nm	\$92.82	Today

EFL = 5.00 mm

Item # (Unmounted / Mounted)	Info	EFL ^a	NA	OD	CA	WD ^b	DW	AR Range	M	Glass	Performance	Thread	Suggested Spanner Wrench
354430-B	i	5.00 mm	0.16	2.00 mm	1.6 / 1.4 mm	4.37 mm	1550 nm	600 - 1050 nm	∞	D-ZK3	430_Asph.pdf	-	-
C430TME-B				6.24 mm		3.37 mm						M6 x 0.5	SPW306

- a. EFL is specified at the design wavelength for the unmounted lens.
b. WD is specified at the design wavelength.

EFL = Effective Focal Length
NA = Numerical Aperture
CA = Clear Aperture

WD = Working Distance
DW = Design Wavelength

OD = Outer Diameter
M = Magnification

Part Number	Description	Price	Availability
354430-B	f = 5.0 mm, NA = 0.16, Unmounted Geltech Aspheric Lens, AR: 600-1050 nm	\$74.21	Today
C430TME-B	f = 5.0 mm, NA = 0.16, Mounted Geltech Aspheric Lens, AR: 600-1050 nm	\$79.31	Today

EFL = 6.xx mm

Item # (Unmounted / Mounted)	Info	EFL ^a	NA	OD	CA	WD ^b	DW	AR Range	M	Glass	Performance	Thread	Suggested Spanner Wrench
354171-B	i	6.20 mm	0.30	4.7 mm	3.70 mm	3.44 mm ^c	633 nm	600 - 1050 nm	∞	D-ZK3	Focal Shift Spot Size Cross Section	-	-

C171TMD-B				8.2 mm		2.84 mm							M8 x 0.5	SPW308
355110-B	i	6.24 mm	0.40	7.2 mm	5.00 mm	2.69 mm ^c	780 nm	600 - 1050 nm	∞	D-ZLaF52LA	Focal Shift	-	-	
C110TMD-B				9.2 mm		1.59 mm ^c								Spot Size Cross Section
A110-B	i	6.24 mm	0.40	7.20 mm	5.00 mm	3.39 mm	780 nm	650 - 1050 nm	∞	H-LaK54	A110_Asph.pdf	-	-	
A110TM-B				9.24 mm		2.39 mm								Spot Size Cross Section

- a. EFL is specified at the design wavelength for the unmounted lens.
b. WD is specified at the design wavelength.
c. This working distance is measured from the lens to the window of the laser diode being collimated (not the emission point).

EFL = Effective Focal Length
NA = Numerical Aperture
CA = Clear Aperture

WD = Working Distance
DW = Design Wavelength

OD = Outer Diameter
M = Magnification

Part Number	Description	Price	Availability
354171-B	f = 6.20 mm, NA = 0.30, Unmounted Geltech Aspheric Lens, AR: 600-1050 nm	\$54.32	Today
C171TMD-B	f = 6.20 mm, NA = 0.30, Mounted Geltech Aspheric Lens, AR: 600-1050 nm	\$72.42	Today
355110-B	f = 6.24 mm, NA = 0.40, Unmounted Geltech Aspheric Lens, AR: 600-1050 nm	\$71.66	Today
C110TMD-B	f = 6.24 mm, NA = 0.40, Mounted Geltech Aspheric Lens, AR: 600-1050 nm	\$86.70	Today
A110-B	f = 6.24 mm, NA = 0.40, Unmounted Rochester Aspheric Lens, AR: 650-1050 nm	\$79.31	Today
A110TM-B	f = 6.24 mm, NA = 0.40, Mounted Rochester Aspheric Lens, AR: 650-1050 nm	\$84.92	Today

EFL = 7.50 mm

Item # (Unmounted / Mounted)	Info	EFL ^a	NA	OD	CA	WD ^b	DW	AR Range	M	Glass	Performance	Thread	Suggested Spanner Wrench
A375-B	i	7.50 mm	0.30	6.51 mm	4.50 mm	5.90 mm	810 nm	650 - 1050 nm	∞	H-LaK54	A375_Asph.pdf	-	-
A375TM-B				9.24 mm		5.59 mm						M9 x 0.5	SPW301

- a. EFL is specified at the design wavelength for the unmounted lens.
b. WD is specified at the design wavelength.

EFL = Effective Focal Length
NA = Numerical Aperture
CA = Clear Aperture

WD = Working Distance
DW = Design Wavelength

OD = Outer Diameter
M = Magnification

Part Number	Description	Price	Availability
A375-B	f = 7.5 mm, NA = 0.3, Unmounted Rochester Aspheric Lens, AR: 650-1050 nm	\$87.47	Today
A375TM-B	f = 7.5 mm, NA = 0.3, Mounted Rochester Aspheric Lens, AR: 650-1050 nm	\$92.82	Today

EFL = 8.00 mm

Item # (Unmounted / Mounted)	Info	EFL ^a	NA	OD	CA	WD ^b	DW	AR Range	M	Glass	Performance	Thread	Suggested Spanner Wrench
352240-B	i	8.00 mm	0.50	9.94 mm	8.00 mm	5.92 mm	780 nm	600 - 1050 nm	∞	ECO-550	240_Asph.pdf	-	-
C240TME-B				12.24 mm		4.93 mm						M12 x 0.5	SPW302
A240-B	i	8.00 mm	0.50	9.94 mm	8.00 mm	5.92 mm	780 nm	650 - 1050 nm	∞	D-LaK6	A240_Asph.pdf	-	-
A240TM-B				12.24 mm		4.79 mm						M12 x 0.5	SPW302

- a. EFL is specified at the design wavelength for the unmounted lens.
b. WD is specified at the design wavelength.



EFL = Effective Focal Length
NA = Numerical Aperture
CA = Clear Aperture

WD = Working Distance
DW = Design Wavelength

OD = Outer Diameter
M = Magnification

Part Number	Description	Price	Availability
352240-B	f = 8.0 mm, NA = 0.5, Unmounted Geltech Aspheric Lens, AR: 600-1050 nm	\$79.31	Today
C240TME-B	f = 8.0 mm, NA = 0.5, Mounted Geltech Aspheric Lens, AR: 600-1050 nm	\$84.92	Today
A240-B	f = 8.0 mm, NA = 0.5, Unmounted Rochester Aspheric Lens, AR: 650-1050 nm	\$79.31	Today
A240TM-B	f = 8.0 mm, NA = 0.5, Mounted Rochester Aspheric Lens, AR: 650-1050 nm	\$84.92	Today

EFL = 11.00 mm

Item # (Unmounted / Mounted)	Info	EFL ^a	NA	OD	CA	WD ^b	DW	AR Range	M	Glass	Performance	Thread	Suggested Spanner Wrench
A397-B		11.00 mm	0.30	7.20 mm	6.59 mm	9.64 mm	633 nm	650 - 1050 nm	∞	H-LaK54	A397_Asph.pdf	-	-
A397TM-B				9.24 mm		8.44 mm						M9 x 0.5	SPW301
A220-B		11.00 mm	0.26	7.20 mm	5.50 mm	7.97 mm	633 nm	650 - 1050 nm	∞	D-K59	A220_Asph.pdf	-	-
A220TM-B				9.24 mm		6.91 mm						M9 x 0.5	SPW301
354220-B		11.00 mm	0.25	7.2 mm	5.50 mm	6.91 mm ^c	633 nm	600 - 1050 nm	∞	D-ZK3	Focal Shift Spot Size Cross Section	-	-
C220TMD-B				9.2 mm		5.81 mm						M9 x 0.5	SPW301

- a. EFL is specified at the design wavelength for the unmounted lens.
b. WD is specified at the design wavelength.
c. This working distance is measured from the lens to the to the window of the laser diode being collimated (not the emission point).

EFL = Effective Focal Length
NA = Numerical Aperture
CA = Clear Aperture

WD = Working Distance
DW = Design Wavelength

OD = Outer Diameter
M = Magnification

Part Number	Description	Price	Availability
A397-B	f = 11.0 mm, NA = 0.3, Unmounted Rochester Aspheric Lens, AR: 650-1050 nm	\$87.47	Today
A397TM-B	f = 11.0 mm, NA = 0.3, Mounted Rochester Aspheric Lens, AR: 650-1050 nm	\$92.82	Today
A220-B	f = 11.0 mm, NA = 0.26, Unmounted Rochester Aspheric Lens, AR: 650-1050 nm	\$79.31	Today
A220TM-B	f = 11.0 mm, NA = 0.26, Mounted Rochester Aspheric Lens, AR: 650-1050 nm	\$84.92	Today
354220-B	f = 11.0 mm, NA = 0.25, Unmounted Geltech Aspheric Lens, AR: 600-1050 nm	\$57.12	Today
C220TMD-B	f = 11.0 mm, NA = 0.25, Mounted Geltech Aspheric Lens, AR: 600-1050 nm	\$72.42	Today

EFL = 13.86 mm

Item # (Unmounted / Mounted)	Info	EFL ^a	NA	OD	CA	WD ^b	DW	AR Range	M	Glass	Performance	Thread	Suggested Spanner Wrench
354560-B		13.86 mm	0.18	6.33 mm	5.10 mm	12.11 mm	650 nm	600 - 1050 nm	∞	D-ZK3	560_Asph.pdf	-	-
C560TME-B				9.24 mm		11.74 mm						M9 x 0.5	SPW301

- a. EFL is specified at the design wavelength for the unmounted lens.
b. WD is specified at the design wavelength.

EFL = Effective Focal Length
NA = Numerical Aperture
CA = Clear Aperture

WD = Working Distance
DW = Design Wavelength

OD = Outer Diameter
M = Magnification

Part Number	Description	Price	Availability
354560-B	f = 13.86 mm, NA = 0.18, Unmounted Geltech Aspheric Lens, AR: 600-1050 nm	\$79.31	Today
C560TME-B	f = 13.86 mm, NA = 0.18, Mounted Geltech Aspheric Lens, AR: 600-1050 nm	\$84.92	Today

EFL = 15.29 mm

Item # (Unmounted / Mounted)	Info	EFL ^a	NA	OD	CA	WD ^b	DW	AR Range	M	Glass	Performance	Thread	Suggested Spanner Wrench
354260-B	📘	15.29 mm	0.16	6.5 mm	5.00 mm	12.73 mm ^c	780 nm	600 - 1050 nm	∞	D-ZK3	Focal Shift Spot Size Cross Section	-	-
C260TMD-B				9.2 mm		12.43 mm ^c						M9 x 0.5	SPW301
A260-B	📘	15.29 mm	0.16	6.50 mm	5.00 mm	14.09 mm	780 nm	650 - 1050 nm	∞	H-LaK54	A260_Asph.pdf	-	-
A260TM-B				9.24 mm		13.84 mm						M9 x 0.5	SPW301

a. EFL is specified at the design wavelength for the unmounted lens.
 b. WD is specified at the design wavelength.
 c. This working distance is measured from the lens to the window of the laser diode being collimated (not the emission point).

EFL = Effective Focal Length
 NA = Numerical Aperture
 CA = Clear Aperture

WD = Working Distance
 DW = Design Wavelength

OD = Outer Diameter
 M = Magnification

Part Number	Description	Price	Availability
354260-B	f = 15.29 mm, NA = 0.16, Unmounted Geltech Aspheric Lens, AR: 600-1050 nm	\$62.73	Today
C260TMD-B	f = 15.29 mm, NA = 0.16, Mounted Geltech Aspheric Lens, AR: 600-1050 nm	\$80.58	Today
A260-B	f = 15.29 mm, NA = 0.16, Unmounted Rochester Aspheric Lens, AR: 650-1050 nm	\$79.31	Today
A260TM-B	f = 15.29 mm, NA = 0.16, Mounted Rochester Aspheric Lens, AR: 650-1050 nm	\$84.92	Today

EFL = 18.40 mm

Item # (Unmounted / Mounted)	Info	EFL ^a	NA	OD	CA	WD ^b	DW	AR Range	M	Glass	Performance	Thread	Suggested Spanner Wrench
354280-B	📘	18.40 mm	0.15	6.5 mm	5.50 mm	15.86 ^c mm	780 nm	600 - 1050 nm	∞	D-ZK3	Focal Shift Spot Size Cross Section	-	-
C280TMD-B				9.2 mm		15.56 ^c mm						M9 x 0.5	SPW301
A280-B	📘	18.40 mm	0.15	6.50 mm	5.50 mm	17.13 mm	780 nm	650 - 1050 nm	∞	H-LaK54	A280_Asph.pdf	-	-
A280TM-B				9.24 mm		16.88 mm						M9 x 0.5	SPW301

a. EFL is specified at the design wavelength for the unmounted lens.
 b. WD is specified at the design wavelength.
 c. This working distance is measured from the lens to the window of the laser diode being collimated (not the emission point).

EFL = Effective Focal Length
 NA = Numerical Aperture
 CA = Clear Aperture

WD = Working Distance
 DW = Design Wavelength

OD = Outer Diameter
 M = Magnification

Part Number	Description	Price	Availability
354280-B	f = 18.40 mm, NA = 0.15, Unmounted Geltech Aspheric Lens, AR: 600-1050 nm	\$62.73	Today
C280TMD-B	f = 18.40 mm, NA = 0.15, Mounted Geltech Aspheric Lens, AR: 600-1050 nm	\$80.58	Today
A280-B	f = 18.4 mm, NA = 0.15, Unmounted Rochester Aspheric Lens, AR: 650-1050 nm	\$79.31	Today
A280TM-B	f = 18.4 mm, NA = 0.15, Mounted Rochester Aspheric Lens, AR: 650-1050 nm	\$84.92	Today

Specifications

Glass

AR Coating

Aspheric Coefficients

Surface	Side 1 ^a	Side 2 ^a
R (mm)	5.07	-61.17
k	-4.755395×10^{-1}	0
A ₂	0	0
A ₄	0	4.2977700×10^{-4}
A ₆	$-4.2737234 \times 10^{-6}$	$-1.0625227 \times 10^{-5}$
A ₈	2.9311207×10^{-7}	0
A ₁₀	$-1.3379192 \times 10^{-8}$	0

- a. Side 1 and Side 2 are labeled as ASP1 and ASP2, respectively, on the drawings shown on the *Specifications* tab.

$$z = \frac{Y^2}{R(1 + \sqrt{1 - (1+k)Y^2/R^2})} + A_2Y^2 + A_4Y^4 + A_6Y^6 + A_8Y^8 + A_{10}Y^{10} + A_{12}Y^{12} + A_{14}Y^{14} + A_{16}Y^{16}$$

Legend

z SAG as a Function of Y

k Conic Constant

R Radius of Curvature

A_n nth Order Aspheric Coefficient

Specifications

Glass

AR Coating

Aspheric Coefficients

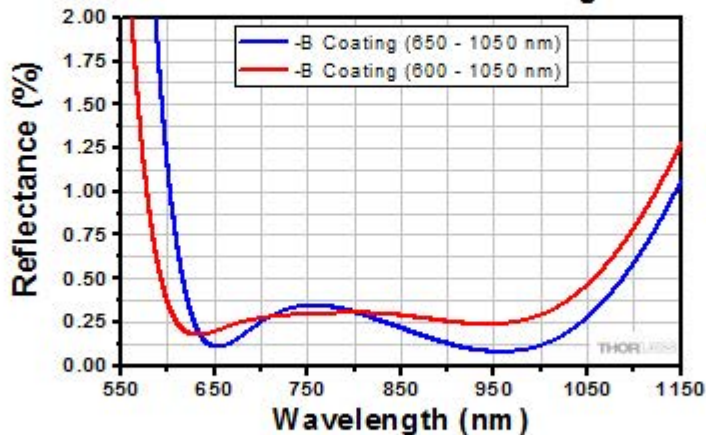
-B Broadband AR CoatingClick [Here](#) to Download Raw Data

Specifications

Glass

AR Coating

Aspheric Coefficients

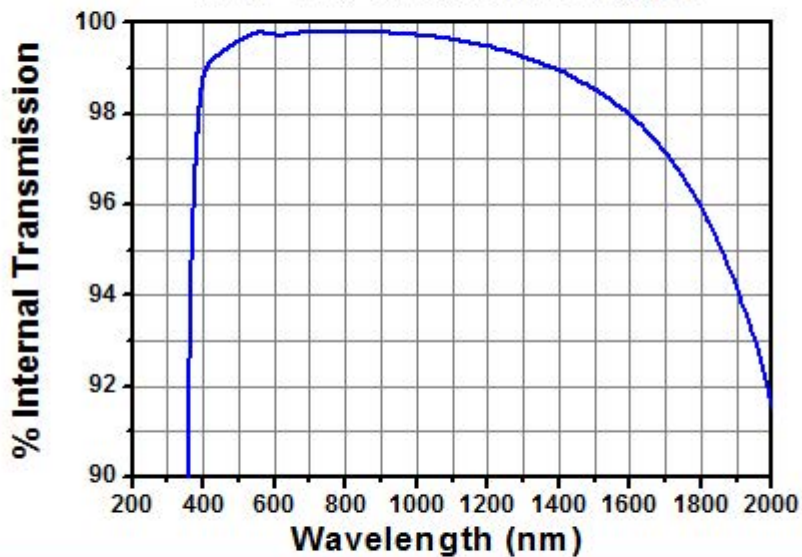
ECO-550, 10 mm Thick Sample**Glass Specifications**

V_d Number	50.28
CTE ($10^{-6} / ^\circ\text{C}$)	11.62
Thermo Optic Coefficient ($10^{-6} / ^\circ\text{C}$) ($\Delta n / \Delta T$)	2.39

Specifications

Glass

AR Coating

Aspheric Coefficients

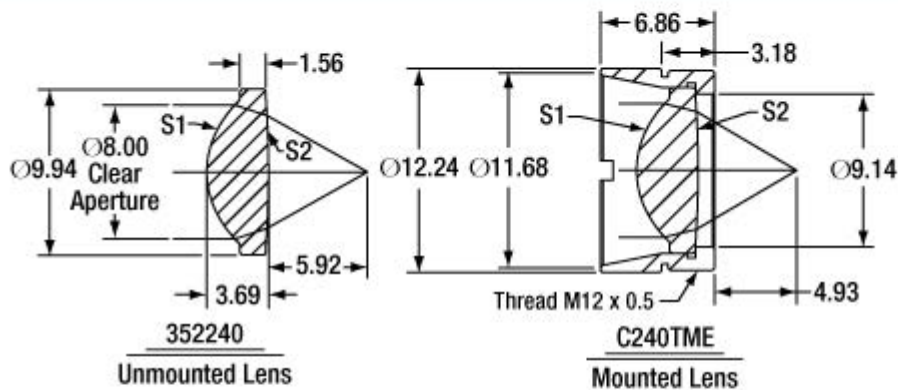

All Dimensions in mm

Lens Specifications

Design Wavelength	780 nm	Magnification	Infinite
Numerical Aperture	0.50	Window Thickness	0.25 mm
Clear Aperture	8.00 mm	Laser Window Material / Index	N-BK7 / 1.517
Effective Focal Length	8.00 mm	Glass	ECO-550
Working Distance	5.92 mm	Surface Quality	40-20 Scratch-Dig (Entire Bulk Material)

Spot Diagrams for Laser Quality Molded Glass Aspheric Lens 352240

Note: Black circle on plots indicates Airy Disk.

At Design Wavelength 780 nm

RMS Radius = 0.19 μm

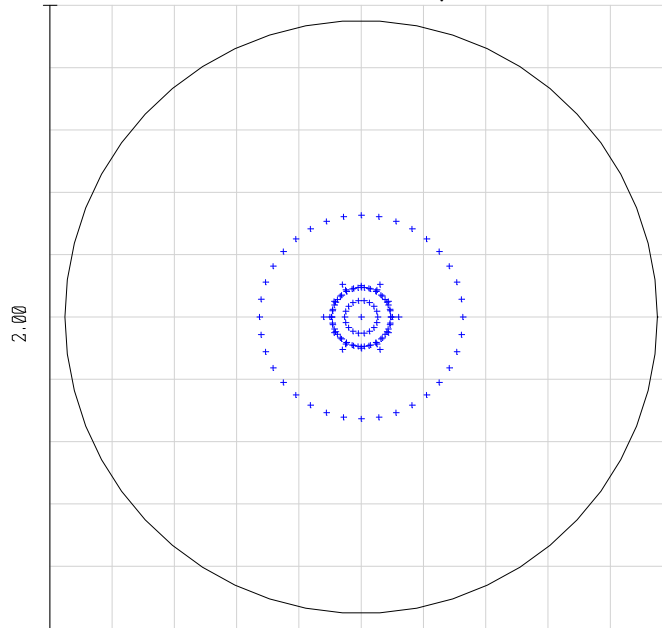

Spot Diagrams for A-Coated Lens (352240-A)

633 nm

RMS Radius = 0.97 μm

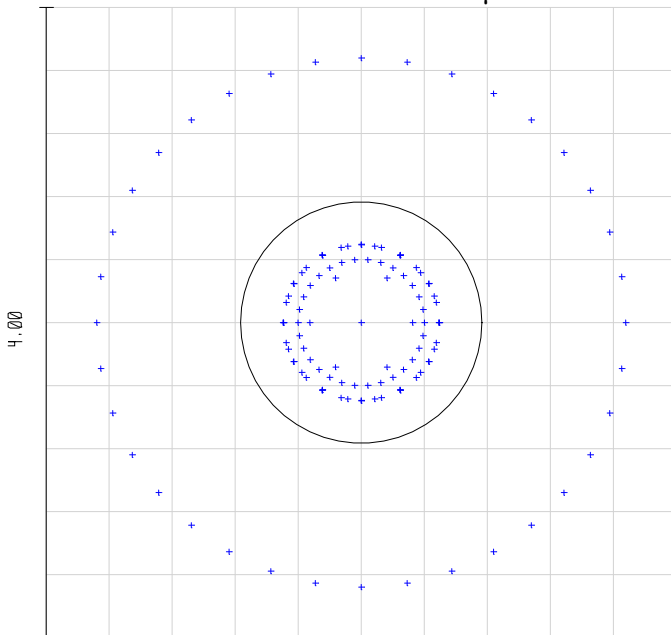

670 nm

RMS Radius = 0.62 μm

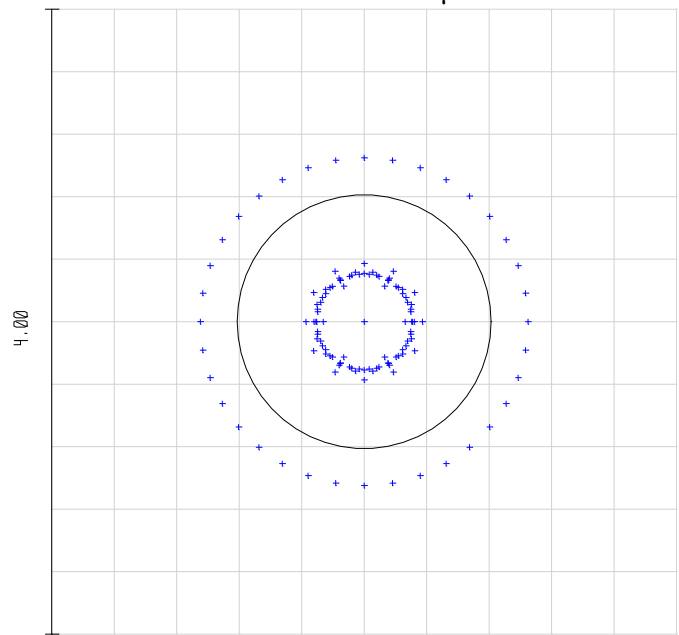

Spot Diagrams for B-Coated Lens (352240-B)

810 nm
RMS Radius = 0.34 μm

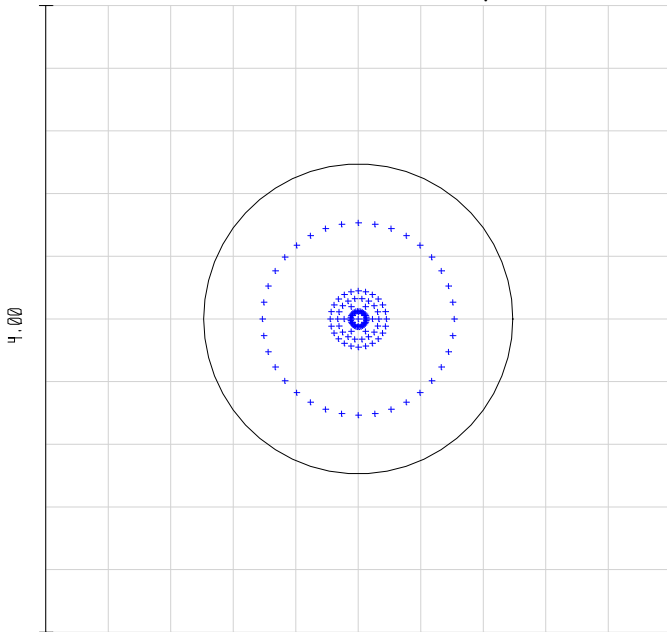

980 nm
RMS Radius = 1.03 μm

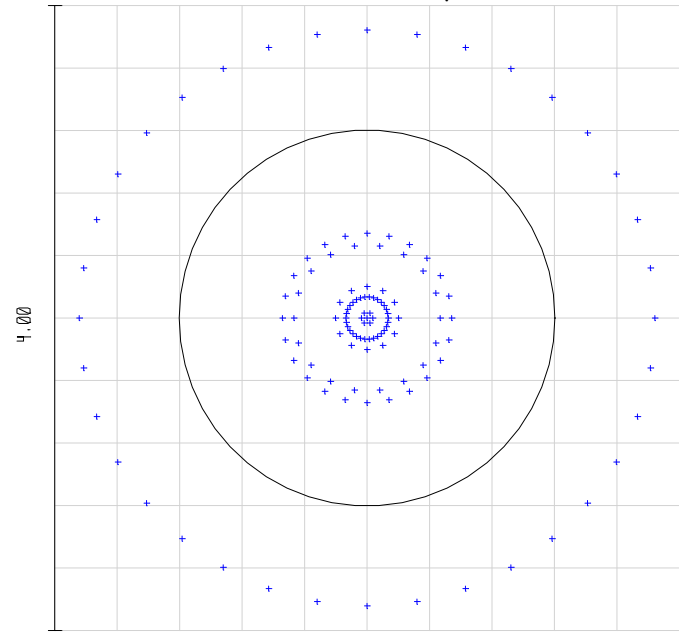

Spot Diagrams for C-Coated Lens (352240-C)

1064 nm
RMS Radius = 1.28 μm

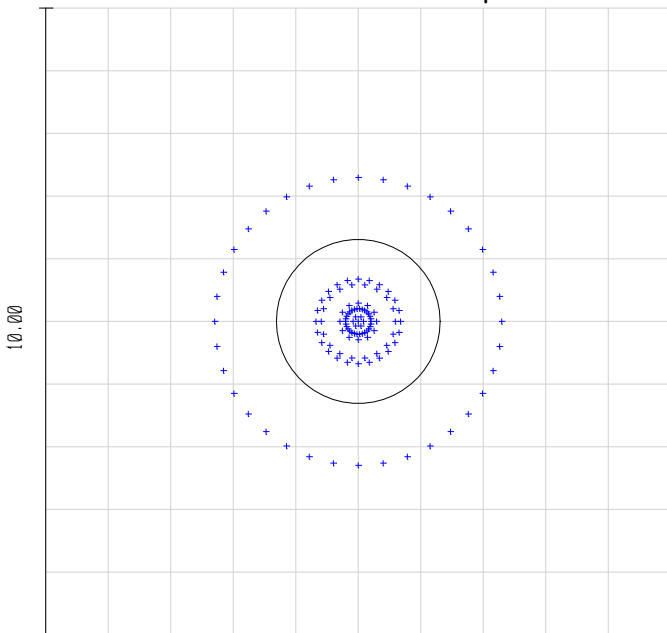

1550 nm
RMS Radius = 2.38 μm

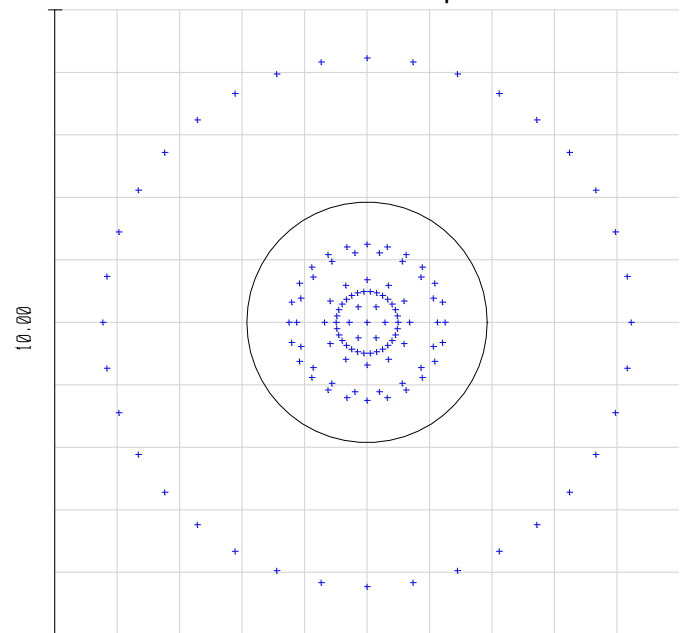

Chromatic Focal Shift

Maximum Focal Shift Range: 622.17 μm (350 – 1620 nm)

Diffraction Limited Range: 3.12 μm

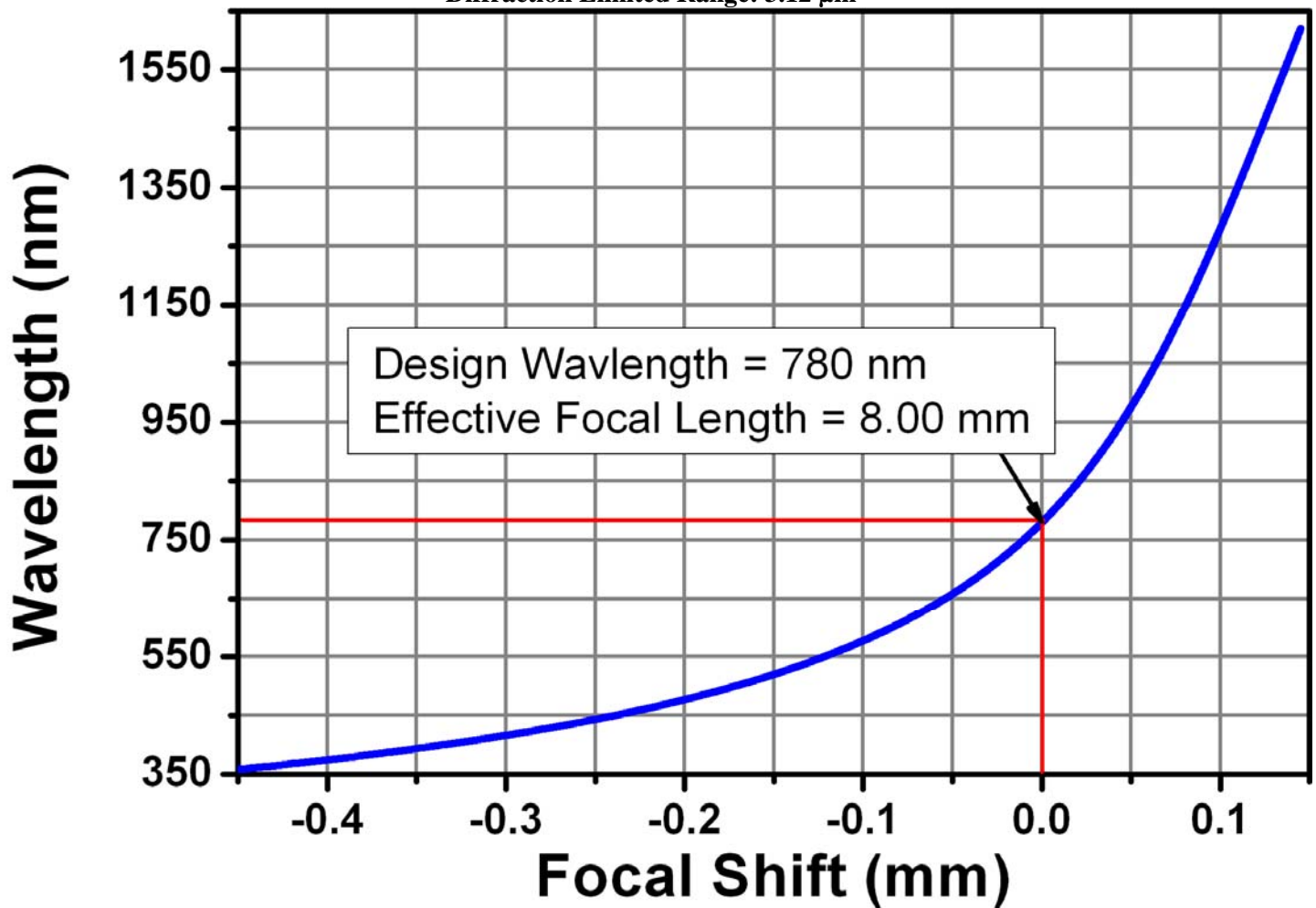

Table showing the focal length at various laser line wavelengths

Wavelength (nm)	Focal Length (mm)
405	7.638
633	7.929
670	7.951
780 ¹	8.000
810	8.011
830	8.018
980	8.057
1064	8.075
1550	8.153

¹ Design Wavelength